

ROAD REPAIR AND ACCOUNTABILITY ACT OF 2017  
PROJECT BASELINE AGREEMENT

Baker Boulevard Bridge Zero-Emission Truck Infrastructure Project

Resolution TCEP-P-2526-17B

(to be completed by CTC)

1. FUNDING PROGRAM

- Active Transportation Program
- Local Partnership Program (Competitive)
- Solutions for Congested Corridors Program
- State Highway Operation and Protection Program
- Trade Corridor Enhancement Program

2. PARTIES AND DATE

- 2.1 This Project Baseline Agreement (Agreement) effective on 5/15/2025 (will be completed by CTC), is made by and between the California Transportation Commission (Commission), the California Department of Transportation (Caltrans), the Project Applicant, SBCTA, and the Implementing Agency, SBCTA and San Bernardino County, sometimes collectively referred to as the "Parties".

3. RECITAL

- 3.1 Whereas at its 6/26/2025 meeting the Commission approved the Trade Corridor Enhancement Program and included in this program of projects the Baker Boulevard Bridge Zero-Emission Truck Infrastructure Project, the parties are entering into this Project Baseline Agreement to document the project cost, schedule, scope and benefits, as detailed on the Project Programming Request Form attached hereto as Exhibit A, the Project Report attached hereto as Exhibit B, the Performance Metrics Form, if applicable, attached hereto as Exhibit C, as the baseline for project monitoring by the Commission.
- 3.2 The undersigned Project Applicant certifies that the funding sources cited are committed and expected to be available; the estimated costs represent full project funding; and the scope and description of benefits is the best estimate possible.

4. GENERAL PROVISIONS

The Project Applicant, Implementing Agency, and Caltrans agree to abide by the following provisions:

- 4.1 To meet the requirements of the Road Repair and Accountability Act of 2017 (Senate Bill [SB] 1, Chapter 5, Statutes of 2017) which provides the first significant, stable, and on-going increase in state transportation funding in more than two decades.
- 4.2 To adhere, as applicable, to the provisions of the Commission:
- Resolution [redacted], "Adoption of Program of Projects for the Active Transportation Program", dated [redacted]
  - Resolution [redacted], "Adoption of Program of Projects for the Local Partnership Program", dated [redacted]
  - Resolution [redacted], "Adoption of Program of Projects for the Solutions for Congested Corridors Program", dated [redacted]
  - Resolution [redacted], "Adoption of Program of Projects for the State Highway Operation and Protection Program", dated [redacted]
  - Resolution TCEP G-25-42, "Adoption of Program of Projects for the Trade Corridor Enhancement Program", dated 6/26/2025

- 4.3 All signatories agree to adhere to the Commission's Guidelines. Any conflict between the programs will be resolved at the discretion of the Commission.
- 4.4 All signatories agree to adhere to the Commission's SB 1 Accountability and Transparency Guidelines and policies, and program and project amendment processes.
- 4.5 SBCTA and San Bernardino County agrees to secure funds for any additional costs of the project.
- 4.6 SBCTA and San Bernardino County agrees to report to Caltrans on a quarterly basis; on the progress made toward the implementation of the project, including scope, cost, schedule, and anticipated benefits/performance metric outcomes.
- 4.7 Caltrans agrees to prepare program progress reports on a on a semi-annual basis and include information appropriate to assess the current state of the overall program and the current status of each project identified in the program report.
- 4.8 SBCTA and San Bernardino County agrees to submit a timely Completion Report and Final Delivery Report as specified in the Commission's SB 1 Accountability and Transparency Guidelines.
- 4.9 SBCTA and San Bernardino County agrees to submit a timely Project Performance Analysis as specified in the Commission's SB 1 Accountability and Transparency Guidelines.
- 4.10 All signatories agree to maintain and make available to the Commission and/or its designated representative, all work related documents, including without limitation engineering, financial and other data, and methodologies and assumptions used in the determination of project benefits and performance metric outcomes during the course of the project, and retain those records for six years from the date of the final closeout of the project. Financial records will be maintained in accordance with Generally Accepted Accounting Principles.
- 4.11 The Inspector General of the Independent Office of Audits and Investigations has the right to audit the project records, including technical and financial data, of the Department of Transportation, the Project Applicant, the Implementing Agency, and any consultant or sub-consultants at any time during the course of the project and for six years from the date of the final closeout of the project, therefore all project records shall be maintained and made available at the time of request. Audits will be conducted in accordance with Generally Accepted Government Auditing Standards.

**5. SPECIFIC PROVISIONS AND CONDITIONS**

5.1 Project Schedule and Cost

See Project Programming Request Form, attached as Exhibit A.

5.2 Project Scope

See Project Report or equivalent, attached as Exhibit B. At a minimum, the attachment shall include the cover page, evidence of approval, executive summary, and a link to or electronic copy of the full document.

5.3 Performance Metrics

See Performance Metrics Form, if applicable, attached as Exhibit C.

5.4 Additional Provisions and Conditions *(Please attach an additional page if additional space is needed.)*

In the event of a cost overrun, the Trade Corridor Enhancement Program shall not be responsible for any cost increase.

**Attachments:**

Exhibit A: Project Programming Request Form

Exhibit B: Project Report

Exhibit C: Performance Metrics Form *(if applicable)*

SIGNATURE PAGE  
TO  
PROJECT BASELINE AGREEMENT

Project Name Baker Boulevard Bridge Zero-Emission Truck Infrastructure Project

Resolution TCEP-P-2526-17B

*(to be completed by CTC)*



Nov 24, 2025

Date

Carolyn Schindler

Executive Director, SBCTA

Project Applicant and Implementing Agency

Approved as to Legal Form:



Nov 21, 2025

Date

Iain MacMillan (Nov 21, 2025 14:50:13 PST)

Iain MacMillan

Assistant General Counsel



02/09/2026

Date

Catalino A. Pining III

District Director

California Department of Transportation



05/19/2026

Date

Cory Binns (May 19, 2026 18:09:49 PDT)

FOR

Director

California Department of Transportation



06/02/2026

Date

Tanisha Taylor

Executive Director

California Transportation Commission

ADDITIONAL SIGNATURE PAGE  
TO  
PROJECT BASELINE AGREEMENT

Project Title: Baker Boulevard Bridge Zero-Emission Truck Infrastructure Project

Resolution: TCEP-P-2526-17B  
(to be completed by CTC)

*Dawn Rowe*

JAN 13 2026

Dawn Rowe

Date

Chair, Board of Supervisors (San Bernardino County)

Implementing Agency

Approved as to Legal Form

*Aaron Gest*

12/3/25

Aaron Gest

Date

Deputy County Counsel

Implementing Agency

SIGNED AND CERTIFIED THAT A COPY OF  
THIS DOCUMENT HAS BEEN DELIVERED  
TO THE CHAIRMAN OF THE BOARD.  
LYNNA MONEEL  
Clerk of the Board of Supervisors  
of San Bernardino County

By

Deputy





**Fact Sheet: Baker Boulevard Bridge and Zero-Emission Truck Infrastructure**  
**Application for TCEP 2024: San Bernardino County Transportation Authority**

**Project Location:** Baker is a small community in unincorporated San Bernardino, an important stopover for trucking and other travelers on Interstate 15, located mid-way between Las Vegas and San Bernardino. The implementing agency for the bridge component will be San Bernardino County, while SBCTA will implement the zero-emission component.

**Project Scope:** The bridge component will replace the existing two-lane, long-timber bridge on Baker Boulevard over the Mojave River, with a new four-lane structure, center median, 10-foot shoulders, and sidewalks on both sides. The existing bridge is approaching 100 years old, and maintenance costs are increasing. The project will also construct a 7 megawatt charging station for zero-emission trucks at a site northeast of the bridge on Baker Blvd. It is a collaborative effort by SBCTA, the County of San Bernardino and WattEV, the purposes of which are to:



- Provide better mobility and safety for this disadvantaged community and circulation for trucks and travelers on I-15 stopping for food, fuel, and rest.
- Address infrastructure resilience (the bridge is well past its expected functional life).
- Preserve the ability of Baker Blvd. to serve as an alternate route in the event of I-15 closures.
- Provide a strategic location for truck charging along I-15

**Project Cost:** Total Project Cost - \$44,856,150.

**TCEP Request:** \$28,911,805 total - \$18,369,000 for Baker Bridge - \$10,542,805 for truck charging

<b>Project Schedule:</b>	<b>PA&amp;ED:</b>	<b>PS&amp;E/RTL:</b>	<b>R/W:</b>	<b>Begin CON:</b>	<b>End CON:</b>
Baker Bridge:	06/25/2025	02/23/2026	11/21/2025	06/02/2026	06/02/2028
Truck Charging:	10/15/2025	04/13/2026	03/16/2026	02/26/2027	03/20/2028

**Project Benefits:**

- **Congestion Reduction:** Eliminates a 1.24 mile detour, in the event the bridge is lost, saving \$87 million in combined travel time and vehicle operating costs over the analysis period.

- **Economics and the Environment** – Generates \$105 million in benefits over costs and a benefit/cost ratio of 3.50. It will create almost 600 jobs from the infrastructure investment and protects and maintains Baker’s Main Street for its residents.
- **VMT and Air Quality** – Reduces VMT by 127 million relative to the no-build scenario in which the bridge (carrying over 9000 vehicles/day) is ultimately lost. Coupled with the Truck Charging Station, the project will eliminate 241,000 metric tons of GHG emissions.
- **Equity:** The U.S. Census shows Baker’s population as 553. The population is 86 percent Hispanic, with a median age of 28.3 years and median household income of about \$32,000 (a third of the median income in California). The project will maintain and improve a critical arterial connection, the loss of which would be devastating to the economy of Baker. Feedback from outreach for the SBCTA Long-Range Multi-Modal Transportation Plan indicates that resiliency and air quality improvements such as this bridge replacement and truck charging station will be highly valued by this rural, disadvantaged community. The project promotes improved safety for motorized and non-motorized travel by including sidewalks and shoulder buffer for cyclists.
- **Advanced Technology** – Deploys Megawatt Charging Standard to allow 20-minute charging for medium and heavy-duty electric trucks
- **Zero-Emissions Infrastructure** – Key component for accelerating the transition of zero-emission trucks on a “Top 6” freight corridor in the CTC’s SB 671 Clean Freight Corridor Efficiency Assessment.
- **Outreach and workforce development for Baker community** – Any investment in Baker is welcome, and the combination of the bridge replacement and truck charging facility will help to modernize Baker’s infrastructure, provide local construction jobs, and give the community a rare opportunity for greater exposure and boost for local businesses. Baker’s signature attraction is the “world’s tallest thermometer.” While this is worth a stop in itself, the bridge and truck charging station investments will secure the community’s future accessibility and provide additional ongoing job opportunities and training. The implementation team (County and WattEV) are both committed to investing in workforce development and job quality for the Baker community. This will include services to help train, place, and retain individuals in jobs to support ongoing charging station operations and green energy.



World's Tallest Thermometer, 2003

Amendment (Existing Project) <input type="checkbox"/> YES <input checked="" type="checkbox"/> NO				Date	08/14/2025 14:36:43
Programs <input type="checkbox"/> LPP-C <input type="checkbox"/> LPP-F <input type="checkbox"/> SCCP <input checked="" type="checkbox"/> TCEP <input type="checkbox"/> STIP <input type="checkbox"/> Other					
District	EA	Project ID	PPNO	Nominating Agency	
08			1349	San Bernardino County Transportation Authority	
County	Route	PM Back	PM Ahead	Co-Nominating Agency	
San Bernardino Cou					
				MPO	Element
				SCAG	Local Assistance
Project Manager/Contact			Phone	Email Address	
Mervat Mikhail, P.E.			909-387-7917	mmikhail@dpw.sbcounty.gov	

**Project Title**

Baker Boulevard Bridge and Zero-Emission Truck Infrastructure Project - Bridge Component

**Location (Project Limits), Description (Scope of Work)**

Location: The Bridge Component of the Baker Boulevard Bridge and Zero-Emission Truck Infrastructure Project is located on Baker Boulevard Between Mill Road and SR-127 in the unincorporated community of Baker in San Bernardino County.

Description: The overall Project will replace the existing two-lane, long timber bridge on Baker Boulevard with a new four-lane structure with a center median, 10-foot shoulders, and sidewalks on both sides and will provide a contribution to zero-emission fueling infrastructure for trucks at a site near the intersection of Baker Boulevard and Van Ella Road.

This ePPR is for the Baker Boulevard bridge replacement.

Component	Implementing Agency
PA&ED	San Bernardino County
PS&E	San Bernardino County
Right of Way	San Bernardino County
Construction	San Bernardino County

**Legislative Districts**

Assembly:	34	Senate:	19	Congressional:	23
-----------	----	---------	----	----------------	----

Project Milestone	Existing	Proposed
Project Study Report Approved	07/03/2024	
Begin Environmental (PA&ED) Phase		08/29/2023
Circulate Draft Environmental Document	Document Type (ND/MND)/CE	01/03/2025
Draft Project Report		02/03/2025
End Environmental Phase (PA&ED Milestone)		06/25/2025
Begin Design (PS&E) Phase		06/26/2025
End Design Phase (Ready to List for Advertisement Milestone)		02/23/2026
Begin Right of Way Phase		06/26/2025
End Right of Way Phase (Right of Way Certification Milestone)		11/21/2025
Begin Construction Phase (Contract Award Milestone)		06/02/2026
End Construction Phase (Construction Contract Acceptance Milestone)		06/02/2028
Begin Closeout Phase		05/01/2028
End Closeout Phase (Closeout Report)		05/01/2029

Date 08/14/2025 14:36:43

**Purpose and Need**

The Baker Boulevard Bridge and Zero-Emission Infrastructure Project will replace the existing two-lane, long timber bridge on Baker Boulevard with a new four-lane concrete and steel structure with a center median, 10-foot shoulders, and sidewalks on both sides. It is a collaborative effort by SBCTA and San Bernardino County, the purposes of which are to:

- Improve structure safety and operations through replacement of the existing bridge and approach roadways.
- Improve safety for all users, both motorized and non-motorized
- Provide a parallel and complementary rural freight corridor to Interstate 15 in the unincorporated community of Baker.

Project Need: Baker Boulevard functions as the main street in the unincorporated community of Baker in San Bernardino County. It is in the process of being designated as a Critical Rural Freight Corridor (CRFC), which connects directly to I-15, a Trade Corridor of National and Regional Significance on the federal Primary Freight Network. Baker Boulevard is a critical component of the local circulation system, but it also acts as an important waystation for auto and truck traffic traversing the desert between Southern California and Las Vegas. Approximately 9500 AADT use this bridge daily, including 40.8% trucks. The existing bridge over the Mojave River was originally built in 1931 as a 93-foot 5-span simple-supported stringer timber bridge. Located 800 feet west of SR-127, it was repaired and lengthened to 408 feet in 1938, as a 22-span timber bridge. Timber railing and plywood planking on the sidewalk is worn and deteriorating. The project will replace the existing two-lane, long-timber bridge with a new four-lane concrete and steel structure that matches the cross-section of Baker Boulevard between the bridge and SR-127.

NHS Improvements <input type="checkbox"/> YES <input checked="" type="checkbox"/> NO	Roadway Class NA	Reversible Lane Analysis <input type="checkbox"/> YES <input checked="" type="checkbox"/> NO
Inc. Sustainable Communities Strategy Goals <input checked="" type="checkbox"/> YES <input type="checkbox"/> NO	Reduce Greenhouse Gas Emissions <input checked="" type="checkbox"/> YES <input type="checkbox"/> NO	

**Project Outputs**

Category	Outputs	Unit	Total
Bridge / Tunnel	Local reconstructed bridge/tunnels	SQFT	43,863
Operational Improvement	Shoulder widening	EA	2
ADA Improvements	New sidewalk	LF	2,806

---

Date 08/14/2025 14:36:43

**Additional Information**

Performance Indicators and Metrics - shows the combined benefits of both project components; Bridge (ePPR-6507-2024-0007), and Zero-Emission (ePPR-6507-2024-0008).

Performance Indicators and Measures						
Measure	Required For	Indicator/Measure	Unit	Build	Future No Build	Change
Congestion Reduction	TCEP	Change in Daily Vehicle Hours of Delay	Hours	35.8	570.2	-534.4
	TCEP	Change in Daily Truck Hours of Delay	Hours	14.6	232.6	-218
Throughput (Freight)	TCEP	Change in Truck Volume	# of Trucks	0	0	0
	TCEP	Change in Rail Volume	# of Trailers	0	0	0
			# of Containers	0	0	0
Velocity (Freight)	TCEP	Travel Time or Total Cargo Transport Time	Hours	0	0	0
Air Quality & GHG (only 'Change' required)	LPPC, SCCP, TCEP, LPPF	Particulate Matter	PM 2.5 Tons	0.4	6.4	-6
			PM 10 Tons	0	2.8	-2.8
	LPPC, SCCP, TCEP, LPPF	Carbon Dioxide (CO2)	Tons	7,290	247,920	-240,630
	LPPC, SCCP, TCEP, LPPF	Volatile Organic Compounds (VOC)	Tons	0	14.3	-14.3
	LPPC, SCCP, TCEP, LPPF	Sulphur Dioxides (SOx)	Tons	0.03	1	-0.97
	LPPC, SCCP, TCEP, LPPF	Carbon Monoxide (CO)	Tons	0	205.7	-205.7
	LPPC, SCCP, TCEP, LPPF	Nitrogen Oxides (NOx)	Tons	13.9	477	-463.1
Safety	LPPC, SCCP, TCEP, LPPF	Number of Fatalities	Number	0	0	0
	LPPC, SCCP, TCEP, LPPF	Fatalities per 100 Million VMT	Number	0	0	0
	LPPC, SCCP, TCEP, LPPF	Number of Serious Injuries	Number	0	0	0
	LPPC, SCCP, TCEP, LPPF	Number of Serious Injuries per 100 Million VMT	Number	0	0	0
Economic Development	LPPC, SCCP, TCEP, LPPF	Jobs Created (Only 'Build' Required)	Number	583,000	0	583,000
Cost Effectiveness (only 'Change' required)	LPPC, SCCP, TCEP, LPPF	Cost Benefit Ratio	Ratio	3.5	0	3.5

District	County	Route	EA	Project ID	PPNO
08	San Bernardino County				1349

**Project Title**  
 Baker Boulevard Bridge and Zero-Emission Truck Infrastructure Project - Bridge Component

Existing Total Project Cost (\$1,000s)									Implementing Agency
Component	Prior	24-25	25-26	26-27	27-28	28-29	29-30+	Total	
E&P (PA&ED)									San Bernardino County
PS&E									San Bernardino County
R/W SUP (CT)									San Bernardino County
CON SUP (CT)									San Bernardino County
R/W									San Bernardino County
CON									San Bernardino County
<b>TOTAL</b>									
Proposed Total Project Cost (\$1,000s)									Notes
Component	Prior	24-25	25-26	26-27	27-28	28-29	29-30+	Total	
E&P (PA&ED)	1,000							1,000	
PS&E		865						865	
R/W SUP (CT)									
CON SUP (CT)									
R/W									
CON			27,930					27,930	
<b>TOTAL</b>	<b>1,000</b>	<b>865</b>	<b>27,930</b>					<b>29,795</b>	

Fund #1:	Local Funds - Local Measure (Committed)								Program Code
Existing Funding (\$1,000s)									Funding Agency
Component	Prior	24-25	25-26	26-27	27-28	28-29	29-30+	Total	
E&P (PA&ED)									San Bernardino County Transportatio
PS&E									
R/W SUP (CT)									
CON SUP (CT)									
R/W									
CON									
<b>TOTAL</b>									
Proposed Funding (\$1,000s)									Notes
Component	Prior	24-25	25-26	26-27	27-28	28-29	29-30+	Total	
E&P (PA&ED)	1,000							1,000	
PS&E		865						865	
R/W SUP (CT)									
CON SUP (CT)									
R/W									
CON									
<b>TOTAL</b>	<b>1,000</b>	<b>865</b>						<b>1,865</b>	

Fund #2:	RSTP - STP Local (Committed)								Program Code
Existing Funding (\$1,000s)									
Component	Prior	24-25	25-26	26-27	27-28	28-29	29-30+	Total	Funding Agency
E&P (PA&ED)									San Bernardino County Transportatio
PS&E									
R/W SUP (CT)									
CON SUP (CT)									
R/W									
CON									
TOTAL									
Proposed Funding (\$1,000s)									
E&P (PA&ED)									TCEP Regional funds Program Code: 20.30.210.320
PS&E									
R/W SUP (CT)									
CON SUP (CT)									
R/W									
CON			9,561					9,561	
TOTAL			9,561					9,561	
Fund #3:	SB1 TCEP - Trade Corridors Enhancement Account (Uncommitted)								
Existing Funding (\$1,000s)									
Component	Prior	24-25	25-26	26-27	27-28	28-29	29-30+	Total	Funding Agency
E&P (PA&ED)									California Transportation Commissio
PS&E									
R/W SUP (CT)									
CON SUP (CT)									
R/W									
CON									
TOTAL									
Proposed Funding (\$1,000s)									
E&P (PA&ED)									TCEP Regional funds Program Code: 20.30.210.320
PS&E									
R/W SUP (CT)									
CON SUP (CT)									
R/W									
CON			18,369					18,369	
TOTAL			18,369					18,369	

Amendment (Existing Project) <input checked="" type="checkbox"/> YES <input type="checkbox"/> NO				Date	04/21/2026
Programs <input type="checkbox"/> LPP-C <input type="checkbox"/> LPP-F <input type="checkbox"/> SCCP <input checked="" type="checkbox"/> TCEP <input type="checkbox"/> STIP <input type="checkbox"/> Other					
District	EA	Project ID	PPNO	Nominating Agency	
08			1350	San Bernardino County Transportation Authority	
County	Route	PM Back	PM Ahead	Co-Nominating Agency	
San Bernardino Cou					
				MPO	Element
				SCAG	Local Assistance
Project Manager/Contact			Phone	Email Address	
Jeffery Hill			909-884-8276	jhill@gosbcta.com	

**Project Title**

Baker Boulevard Bridge and Zero-Emission Truck Infrastructure Project - Zero-Emission Component (Construction)

**Location (Project Limits), Description (Scope of Work)**

Location: The Zero-Emission Component of the Baker Boulevard Bridge and Zero-Emission Truck Infrastructure Project will be located at the Southeast Corner of State Route 127 and Sheridan Avenue in the unincorporated community of Baker in San Bernardino County.

Description: The overall Project will replace the existing two-lane, long timber bridge on Baker Boulevard with a new four-lane structure with a center median, 10-foot shoulders, and sidewalks on both sides and will provide a contribution to zero-emission fueling infrastructure for trucks at the Southeast Corner of State Route 127 and Sheridan Avenue site. The Baker charging depot is conveniently located 0.5 miles from the on/off ramp of I-15, a "Top 6" corridor identified in the SB 671 Clean Freight Corridor Efficiency Assessment. See "Additional Information" section for more details.

This ePPR is for the Zero-Emission Component (Construction). A separate ePPR will be prepared for Procurement.

Component	Implementing Agency
PA&ED	San Bernardino County Transportation Authority
PS&E	San Bernardino County Transportation Authority
Right of Way	San Bernardino County Transportation Authority
Construction	San Bernardino County Transportation Authority

**Legislative Districts**

Assembly:	34	Senate:	19	Congressional:	23
-----------	----	---------	----	----------------	----

Project Milestone	Existing	Proposed
Project Study Report Approved		
Begin Environmental (PA&ED) Phase	08/01/2025	08/01/2025
Circulate Draft Environmental Document <span style="float: right;">Document Type CE</span>	08/10/2025	08/10/2025
Draft Project Report	08/10/2025	08/10/2025
End Environmental Phase (PA&ED Milestone)	08/29/2025	10/15/2025
Begin Design (PS&E) Phase	10/01/2025	11/03/2025
End Design Phase (Ready to List for Advertisement Milestone)	12/20/2025	04/13/2026
Begin Right of Way Phase	01/02/2026	03/09/2026
End Right of Way Phase (Right of Way Certification Milestone)	01/10/2026	03/16/2026
Begin Construction Phase (Contract Award Milestone)	02/13/2026	02/26/2027
End Construction Phase (Construction Contract Acceptance Milestone)	04/16/2027	03/20/2028
Begin Closeout Phase	05/16/2027	04/21/2028
End Closeout Phase (Closeout Report)	08/16/2027	09/25/2028

Date 04/21/2026

**Purpose and Need**

The Baker Boulevard Bridge and Zero-Emission Infrastructure Project will replace the existing two-lane, long timber bridge on Baker Boulevard with a new four-lane concrete and steel structure with a center median, 10-foot shoulders, and sidewalks on both sides. It is a collaborative effort by SBCTA and San Bernardino County, the purposes of which are to:

- Improve structure safety and operations through replacement of the existing bridge and approach roadways.
- Improve safety for all users, both motorized and non-motorized
- Provide a parallel and complementary rural freight corridor to Interstate 15 in the unincorporated community of Baker.

Project Need: Baker Boulevard functions as the main street in the unincorporated community of Baker in San Bernardino County. It is in the process of being designated as a Critical Rural Freight Corridor (CRFC), which connects directly to I-15, a Trade Corridor of National and Regional Significance on the federal Primary Freight Network. Baker Boulevard is a critical component of the local circulation system, but it also acts as an important waystation for auto and truck traffic traversing the desert between Southern California and Las Vegas. Approximately 9500 AADT use this bridge daily, including 40.8% trucks. The Zero-Emission Component of the Project will build a MHDEV fueling station that will become a part of a larger network of stations to encourage the use of MHDEVs. This component of the Project is needed to support the demand and use of a zero-emission fleet necessary to meet the State's GHG reduction goals.

NHS Improvements <input type="checkbox"/> YES <input checked="" type="checkbox"/> NO	Roadway Class NA	Reversible Lane Analysis <input type="checkbox"/> YES <input checked="" type="checkbox"/> NO
Inc. Sustainable Communities Strategy Goals <input checked="" type="checkbox"/> YES <input type="checkbox"/> NO		Reduce Greenhouse Gas Emissions <input checked="" type="checkbox"/> YES <input type="checkbox"/> NO

**Project Outputs**

Category	Outputs	Unit	Total
ZEV infrastructure	Number of Locations with ZEV infrastructure	Each	1
ZEV infrastructure	Number of vehicle stalls available for charging	Each	18

Date 04/21/2026

**Additional Information**

Scope of Work continued:

The Zero-Emission Component of the project includes:

- Deployment of one publicly accessible charging facility to support MHDEV transportation
- Installation of six Gen-3 1.25MW megawatt charging standard (MCS) chargers and two Gen-2 1.2MW MCS chargers, all containing eight MCS dispensers, and 10 combined charging standard (CCS) dispensers capable of charging 32,321 trucks per year at full capacity
- Amenities at the charging stations including bathrooms and security features

"Top 6" corridors represent over 50 percent of average daily truck vehicle miles traveled by medium-duty and heavy-duty trucks across California. In addition to easy access to the interstate, the site is surrounded by existing driver amenities, like popular restaurant chains and truck parking.

Performance Indicators and Metrics - shows the combined benefits of both project components; Bridge (ePPR-6507-2024-0007), and Zero-Emission (ePPR-6507-2024-0008). The Zero-Emission component is then subdivided into a Construction (PPNO 1350) and Procurement (PPNO 1350A). The Procurement ePPR will show nearly zero 'Performance Indicators and Measures' as those would only be achieved upon completion of the Construction component. However, the Procurement ePPR will show 'Outputs' of Simultaneous EV Charging Capacity and the Number of DC Charging Ports.

Project Milestone: Environmental Document - This project component is following AB 1236 for this EV Charging Station project. San Bernardino County, serving as the Authority Having Jurisdiction (AHJ) has submitted a support letter (dated 10/15/25) that they will review permits for this ministerial project, and thus it follows non-discretionary review, and is "exempt from requirements of California Environmental Quality Act (CEQA)" pursuant to CEQA Guidelines section 15268(a). Begin Construction (Contract Award): SBCTA will seek a construction component allocation time extension request before the June'26 allocation deadline (FY25/26 programmed funds). Construction component anticipated for allocation at the January 2027 CTC meeting.

Zero-Emission Component Location Change: Since the submittal of our project application, the location identified for the Zero-Emission Truck Infrastructure component of the project has moved due to an unrecorded utility easement making the location unviable. Despite the owner's best efforts to remove the easement, the existing utility agreement granted the utility company the right to use the property for utility purposes without being formally registered with the county or other relevant authorities; therefore, the easement did not show up on a standard title search. The physical address has changed from 72522 Baker Boulevard to the Southeast corner of Hwy-127 and Sheridan Avenue (no current address assigned), still within the unincorporated community of the City of Baker in San Bernardino County (approximately a half mile west). The new location will still include all Project Outputs (number of charging stations, number of vehicle stalls available for charging, and kW simultaneous EV charging capacity) as identified in the Zero-Emission Component Project Programming Request (PPR). The Performance Indicators and Measures as originally reported will also be unaffected. The new site has been vetted, and no major developing issues were identified. A topography, boundary, and utilities survey report has been issued and incorporated into the site plan.

Performance Indicators and Measures						
Measure	Required For	Indicator/Measure	Unit	Build	Future No Build	Change
Congestion Reduction	TCEP	Change in Daily Vehicle Hours of Delay	Hours	35.8	570.2	-534.4
	TCEP	Change in Daily Truck Hours of Delay	Hours	14.6	232.6	-218
Throughput (Freight)	TCEP	Change in Truck Volume	# of Trucks	0	0	0
	TCEP	Change in Rail Volume	# of Trailers	0	0	0
			# of Containers	0	0	0
Velocity (Freight)	TCEP	Travel Time or Total Cargo Transport Time	Hours	0	0	0
Air Quality & GHG (only 'Change' required)	LPPC, SCCP, TCEP, LPPF	Particulate Matter	PM 2.5 Tons	0.4	6.4	-6
			PM 10 Tons	0	2.8	-2.8
	LPPC, SCCP, TCEP, LPPF	Carbon Dioxide (CO2)	Tons	7,290	247,920	-240,630
	LPPC, SCCP, TCEP, LPPF	Volatile Organic Compounds (VOC)	Tons	0	14.3	-14.3
	LPPC, SCCP, TCEP, LPPF	Sulphur Dioxides (SOx)	Tons	0.03	1	-0.97
	LPPC, SCCP, TCEP, LPPF	Carbon Monoxide (CO)	Tons	0	205.7	-205.7
	LPPC, SCCP, TCEP, LPPF	Nitrogen Oxides (NOx)	Tons	13.9	477	-463.1
Safety	LPPC, SCCP, TCEP, LPPF	Number of Fatalities	Number	0	0	0
	LPPC, SCCP, TCEP, LPPF	Fatalities per 100 Million VMT	Number	0	0	0
	LPPC, SCCP, TCEP, LPPF	Number of Serious Injuries	Number	0	0	0
	LPPC, SCCP, TCEP, LPPF	Number of Serious Injuries per 100 Million VMT	Number	0	0	0
Economic Development	LPPC, SCCP, TCEP, LPPF	Jobs Created (Only 'Build' Required)	Number	583,000	0	583,000
Cost Effectiveness (only 'Change' required)	LPPC, SCCP, TCEP, LPPF	Cost Benefit Ratio	Ratio	3.5	0	3.5

District	County	Route	EA	Project ID	PPNO
08	San Bernardino County				1350

Project Title  
 Baker Boulevard Bridge and Zero-Emission Truck Infrastructure Project - Zero-Emission Component (Construction)

Existing Total Project Cost (\$1,000s)									Implementing Agency
Component	Prior	23-24	24-25	25-26	26-27	27-28	28-29+	Total	
E&P (PA&ED)									San Bernardino County Transportatic
PS&E			345					345	San Bernardino County Transportatic
R/W SUP (CT)									San Bernardino County Transportatic
CON SUP (CT)									San Bernardino County Transportatic
R/W									San Bernardino County Transportatic
CON				14,716				14,716	San Bernardino County Transportatic
<b>TOTAL</b>			345	14,716				15,061	

Proposed Total Project Cost (\$1,000s)									Notes
Component	Prior	23-24	24-25	25-26	26-27	27-28	28-29+	Total	
E&P (PA&ED)									
PS&E									
R/W SUP (CT)									
CON SUP (CT)									
R/W									
CON				7,061				7,061	
<b>TOTAL</b>				7,061				7,061	

Fund #1:	Local Funds - Private Funds (Committed)								Program Code
Existing Funding (\$1,000s)									20.10.400.100
Component	Prior	23-24	24-25	25-26	26-27	27-28	28-29+	Total	Funding Agency
E&P (PA&ED)									
PS&E			345					345	
R/W SUP (CT)									
CON SUP (CT)									
R/W									
CON				4,173				4,173	
<b>TOTAL</b>			345	4,173				4,518	

Proposed Funding (\$1,000s)									Notes
Component	Prior	23-24	24-25	25-26	26-27	27-28	28-29+	Total	
E&P (PA&ED)									Funding to be provided by WattEV. Private contribution remains the same, the funding has just been split with the creation of a Procurement Allocation (PPNO 1350A).
PS&E									
R/W SUP (CT)									
CON SUP (CT)									
R/W									
CON				2,118				2,118	
<b>TOTAL</b>				2,118				2,118	

Fund #2:	SB1 TCEP - Trade Corridors Enhancement Account (Committed)								Program Code
Existing Funding (\$1,000s)									20.30.210.320
Component	Prior	23-24	24-25	25-26	26-27	27-28	28-29+	Total	Funding Agency
E&P (PA&ED)									San Bernardino County Transportatic TCEP Regional funds Program Code: 20.30.210.320
PS&E									
R/W SUP (CT)									
CON SUP (CT)									
R/W									
CON				10,543				10,543	
TOTAL				10,543				10,543	
Proposed Funding (\$1,000s)									Notes
E&P (PA&ED)									Total TCEP award to the Zero-Emission Component remains \$10.543M. The award is just being split into a new Procurement Allocation (PPNO 1350A).
PS&E									
R/W SUP (CT)									
CON SUP (CT)									
R/W									
CON				4,943				4,943	
TOTAL				4,943				4,943	

**Complete this page for amendments only**

Date 04/21/2026

District	County	Route	EA	Project ID	PPNO
08	San Bernardino County				1350

**SECTION 1 - All Projects**

**Project Background**

The Baker Boulevard project is in the process of preparing the TCEP Baseline Agreement. While the Bridge component has its environmental document complete, the zero-emission (charging station) component has been working to secure a support letter from San Bernardino County, the Authority Having Jurisdiction (AHJ) that the project will follow their AB 1236 policy/process and is exempt from CEQA review. This support letter will serve as the environmental document stand-in, within the Baseline Agreement. This amendment updates the 'End Environmental Phase (PA&ED Milestone)' to match the current support letter, as well as the Begin Construction Date to match the anticipated Baseline Agreement and CTC allocation date.

**Programming Change Requested**

The funding table is being updated on Feb'26 to split the original awarded TCEP funding for the zero-emission project component into two separate allocations. This ePPR will maintain the original PPNO number of 1350 and become the Construction Allocation. A new ePPR will be created for a new PPNO number (1350A) which will be the Procurement Allocation. Please note that there is not change to the total programming of Private or TCEP funding to this project, just a splitting of the funds into the two allocations.

**Reason for Proposed Change**

The first Env Doc Support Letter received from San Bernardino County was deemed inadequate by Caltrans. SBCTA worked with Caltrans and San Bernardino County staff to determine sufficient language and revise the support letter. The current letter is dated 10/15/25 and the PA&ED Milestone date has been updated to match. This coordination and support letter revision has delayed Baseline Agreement development beyond the necessary SBCTA and San Bernardino County signature preparation schedules and thus will not make a January CTC meeting for Baseline Agreement presentation and TCEP Allocation. For this reason, the Construction Start Date has also been updated to match the anticipated March CTC date.

If proposed change will delay one or more components, clearly explain 1) reason for the delay, 2) cost increase related to the delay, and 3) how cost increase will be funded

**Other Significant Information**

**SECTION 2 - For SB1 Project Only**

Project Amendment Request (Please follow the individual SB1 program guidelines for specific criteria)

Please let SBCTA know if these changes constitute a formal amendment request. While the dates have altered from what was originally submitted in the project application, they've updated as a requirement for, and for the intent to deliver the Baseline Agreement.

**Approvals**

I hereby certify that the above information is complete and accurate and all approvals have been obtained for the processing of this amendment request.

Name (Print or Type)	Signature	Title	Date

**SECTION 3 - All Projects**

**Attachments**

- 1) Concurrence from Implementing Agency and/or Regional Transportation Planning Agency
- 2) Project Location Map

Amendment (Existing Project) <input type="checkbox"/> YES <input checked="" type="checkbox"/> NO				Date	04/21/2026
Programs <input type="checkbox"/> LPP-C <input type="checkbox"/> LPP-F <input type="checkbox"/> SCCP <input checked="" type="checkbox"/> TCEP <input type="checkbox"/> STIP <input checked="" type="checkbox"/> Other					
District	EA	Project ID	PPNO	Nominating Agency	
08			1350A	San Bernardino County Transportation Authority	
County	Route	PM Back	PM Ahead	Co-Nominating Agency	
San Bernardino Cou				MPO	Element
				SCAG	Local Assistance
Project Manager/Contact			Phone	Email Address	
Jeffery Hill			909-884-8276	jhill@gosbcta.com	

**Project Title**

Baker Boulevard Bridge and Zero-Emission Truck Infrastructure Project - Zero-Emission Component (Procurement)

**Location (Project Limits), Description (Scope of Work)**

Location: The Zero-Emission Component of the Baker Boulevard Bridge and Zero-Emission Truck Infrastructure Project will be located at the Southeast Corner of State Route 127 and Sheridan Avenue in the unincorporated community of Baker in San Bernardino County.

Description: The overall Project will replace the existing two-lane, long timber bridge on Baker Boulevard with a new four-lane structure with a center median, 10-foot shoulders, and sidewalks on both sides and will provide a contribution to zero-emission fueling infrastructure for trucks at the Southeast Corner of State Route 127 and Sheridan Avenue site. The Baker charging depot is conveniently located 0.5 miles from the on/off ramp of I-15, a "Top 6" corridor identified in the SB 671 Clean Freight Corridor Efficiency Assessment. See "Additional Information" section for more details.

This ePPR is for the Zero-Emission Component (Procurement): See Additional Notes Section

Component	Implementing Agency
PA&ED	San Bernardino County Transportation Authority
PS&E	San Bernardino County Transportation Authority
Right of Way	San Bernardino County Transportation Authority
Construction	San Bernardino County Transportation Authority

**Legislative Districts**

Assembly:	34	Senate:	19	Congressional:	23
-----------	----	---------	----	----------------	----

Project Milestone	Existing	Proposed
Project Study Report Approved		
Begin Environmental (PA&ED) Phase	08/01/2025	08/01/2025
Circulate Draft Environmental Document <span style="float: right;">Document Type</span>	08/10/2025	08/10/2025
Draft Project Report	08/10/2025	08/10/2025
End Environmental Phase (PA&ED Milestone)	08/29/2025	08/29/2025
Begin Design (PS&E) Phase	10/01/2025	11/03/2025
End Design Phase (Ready to List for Advertisement Milestone)	12/20/2025	04/13/2026
Begin Right of Way Phase	01/02/2026	03/09/2026
End Right of Way Phase (Right of Way Certification Milestone)	01/10/2026	03/16/2026
Begin Construction Phase (Contract Award Milestone)	02/13/2026	05/16/2026
End Construction Phase (Construction Contract Acceptance Milestone)	04/16/2027	03/20/2028
Begin Closeout Phase	05/16/2027	04/21/2028
End Closeout Phase (Closeout Report)	08/16/2027	09/25/2028

Date 04/21/2026

**Purpose and Need**

The TCEP application included two project components: Baker Bridge (PPNO 1349) and the Zero-Emission Component (Construction) (PPNO 1350). This ePPR focuses on the early procurement of electrical assets needed for construction (PPNO 1350A).

The Baker Boulevard Bridge and Zero-Emission Infrastructure Project will replace the existing two-lane, long timber bridge on Baker Boulevard with a new four-lane concrete and steel structure with a center median, 10-foot shoulders, and sidewalks on both sides. It is a collaborative effort by SBCTA and San Bernardino County, the purposes of which are to:

- Improve structure safety and operations through replacement of the existing bridge and approach roadways.
- Improve safety for all users, both motorized and non-motorized
- Provide a parallel and complementary rural freight corridor to Interstate 15 in the unincorporated community of Baker.

**Procurement Allocation Need:**

Electrical equipment right now is in high demand with very long lead times. The electrical manufacturer provided an estimate in Feb'26 of 14-18 months lead time. The equipment needed includes a medium voltage switch gear, packaged substation with transformer and latest charging equipment compliant with MCS standard.

NHS Improvements <input type="checkbox"/> YES <input checked="" type="checkbox"/> NO	Roadway Class NA	Reversible Lane Analysis <input type="checkbox"/> YES <input checked="" type="checkbox"/> NO
Inc. Sustainable Communities Strategy Goals <input type="checkbox"/> YES <input checked="" type="checkbox"/> NO	Reduce Greenhouse Gas Emissions <input type="checkbox"/> YES <input checked="" type="checkbox"/> NO	

**Project Outputs**

Category	Outputs	Unit	Total
ZEV infrastructure	Number of DC charging ports	Each	18
ZEV infrastructure	Simultaneous EV charging capacity	kW	4,900

Date 04/21/2026

**Additional Information**

Scope of Work continued:

The Zero-Emission Component of the project includes:

- Deployment of one publicly accessible charging facility to support MHDEV transportation
- Installation of six Gen-3 1.25MW megawatt charging standard (MCS) chargers and two Gen-2 1.2MW MCS chargers, all containing eight MCS dispensers, and 10 combined charging standard (CCS) dispensers capable of charging 32,321 trucks per year at full capacity
- Amenities at the charging stations including bathrooms and security features

"Top 6" corridors represent over 50 percent of average daily truck vehicle miles traveled by medium-duty and heavy-duty trucks across California. In addition to easy access to the interstate, the site is surrounded by existing driver amenities, like popular restaurant chains and truck parking.

SBCTA was awarded \$10.543M for the Zero-Emission Component of the 'Baker Blvd and Zero-Emission Truck Infrastructure Project'. There will be two SBCTA ePPRs for this award; one for the Procurement Allocation and one for the Construction Allocation (both programmed in the construction phase). These two ePPRs only show the TCEP awarded funds and their required match. A total project funding would require combining three ePPRs; San Bernardino County's Bridge component, the Zero-Emission Component (Procurement Allocation), and the Zero-Emission Component (Construction Allocation).

Category and Outputs & Performance Indicators and Metrics: Outputs are not considered delivered until completion of the Zero-Emission Component (Construction) PPNO 1350 is complete.

**Project Milestone:**

Environmental Document - This project component is following AB 1236 for this EV Charging Station project. San Bernardino County, serving as the Authority Having Jurisdiction (AHJ) has submitted a support letter (dated 10/15/25) that they will review permits for this ministerial project, and thus it follows non-discretionary review, and is "exempt from requirements of California Environmental Quality Act (CEQA)" pursuant to CEQA Guidelines section 15268(a).

Begin Construction (Contract Award): The Procurement component anticipates allocation at the May'26 CTC meeting.

**Zero-Emission Component Location Change (b/w TCEP Application, and Baseline Agreement):**

Since the submittal of our project application, the location identified for the Zero-Emission Truck Infrastructure component of the project has moved due to an unrecorded utility easement making the location unviable. Despite the owner's best efforts to remove the easement, the existing utility agreement granted the utility company the right to use the property for utility purposes without being formally registered with the county or other relevant authorities; therefore, the easement did not show up on a standard title search. The physical address has changed from 72522 Baker Boulevard to the Southeast corner of Hwy-127 and Sheridan Avenue (no current address assigned), still within the unincorporated community of the City of Baker in San Bernardino County (approximately a half mile west). The new location will still include all Project Outputs (number of charging stations, number of vehicle stalls available for charging, and kW simultaneous EV charging capacity) as identified in the Zero-Emission Component Project Programming Request (PPR). The Performance Indicators and Measures as originally reported will also be unaffected. The new site has been vetted, and no major developing issues were identified. A topography, boundary, and utilities survey report has been issued and incorporated into the site plan.

Performance Indicators and Measures						
Measure	Required For	Indicator/Measure	Unit	Build	Future No Build	Change
Performance Indicators and Measures						
Measure	Required For	Indicator/Measure	Unit	Build	Future No Build	Change
Congestion Reduction	TCEP	Change in Daily Vehicle Hours of Delay	Hours	0.001	0	0.001
	TCEP	Daily Vehicle Hours of Travel Time Reduction	Hours	0	0	0
	TCEP	Change in Daily Truck Hours of Delay	Hours	0	0	0
Throughput (Freight)	TCEP	Change in Truck Volume	# of Trucks	0	0	0
	TCEP	Change in Rail Volume	# of Trailers	0	0	0
			# of Containers	0	0	0
Velocity (Freight)	TCEP	Travel Time or Total Cargo Transport Time	Hours	0	0	0
Air Quality & GHG (only 'Change' required)	LPPC, SCCP, TCEP, LPPF	Particulate Matter	PM 2.5 Tons	0	0	0
			PM 10 Tons	0	0	0
	LPPC, SCCP, TCEP, LPPF	Carbon Dioxide (CO2)	Tons	0	0	0
	LPPC, SCCP, TCEP, LPPF	Volatile Organic Compounds (VOC)	Tons	0	0	0
	LPPC, SCCP, TCEP, LPPF	Sulphur Dioxides (SOx)	Tons	0	0	0
	LPPC, SCCP, TCEP, LPPF	Carbon Monoxide (CO)	Tons	0	0	0
	LPPC, SCCP, TCEP, LPPF	Nitrogen Oxides (NOx)	Tons	0	0	0
Safety	LPPC, SCCP, TCEP, LPPF	Number of Fatalities	Number	0	0	0
	LPPC, SCCP, TCEP, LPPF	Fatalities per 100 Million VMT	Number	0	0	0
	LPPC, SCCP, TCEP, LPPF	Number of Serious Injuries	Number	0	0	0
	LPPC, SCCP, TCEP, LPPF	Number of Serious Injuries per 100 Million VMT	Number	0	0	0
Economic Development	LPPC, SCCP, TCEP, LPPF	Jobs Created (Only 'Build' Required)	Number	0	0	0
Cost Effectiveness (only 'Change' required)	LPPC, SCCP, TCEP, LPPF	Cost Benefit Ratio	Ratio	0	0	0
Truck & Vehicle Volume (Freight)	TCEP	Existing Average Annual Vehicle Volume on Project Segment	Percent	0	0	0
	TCEP	Existing Average Annual Truck Percent on Project Segment	Percent	0	0	0

Performance Indicators and Measures						
Measure	Required For	Indicator/Measure	Unit	Build	Future No Build	Change
	TCEP	Estimated Year 20 Average Annual Vehicle Volume on Project Segment with Project	Number	0	0	0
	TCEP	Estimated Year 20 Average Annual Truck Percent on Project Segment with Project	Number	0	0	0

District	County	Route	EA	Project ID	PPNO
08	San Bernardino County				1350A

Project Title  
 Baker Boulevard Bridge and Zero-Emission Truck Infrastructure Project - Zero-Emission Component (Procurement)

Existing Total Project Cost (\$1,000s)									Implementing Agency
Component	Prior	23-24	24-25	25-26	26-27	27-28	28-29+	Total	
E&P (PA&ED)									San Bernardino County Transportatic
PS&E									San Bernardino County Transportatic
R/W SUP (CT)									San Bernardino County Transportatic
CON SUP (CT)									San Bernardino County Transportatic
R/W									San Bernardino County Transportatic
CON									San Bernardino County Transportatic
TOTAL									

Proposed Total Project Cost (\$1,000s)									Notes
Component	Prior	23-24	24-25	25-26	26-27	27-28	28-29+	Total	
E&P (PA&ED)									
PS&E									
R/W SUP (CT)									
CON SUP (CT)									
R/W									
CON				8,000				8,000	
TOTAL				8,000				8,000	

Fund #1:	Local Funds - Private Funds (Committed)								Program Code
	Existing Funding (\$1,000s)								20.10.400.100
Component	Prior	23-24	24-25	25-26	26-27	27-28	28-29+	Total	Funding Agency
E&P (PA&ED)									
PS&E									
R/W SUP (CT)									
CON SUP (CT)									
R/W									
CON									
TOTAL									

Proposed Funding (\$1,000s)									Notes
Component	Prior	23-24	24-25	25-26	26-27	27-28	28-29+	Total	
E&P (PA&ED)									These funds will be provided by WattEV
PS&E									
R/W SUP (CT)									
CON SUP (CT)									
R/W									
CON				2,400				2,400	
TOTAL				2,400				2,400	

Fund #:	SB1 TCEP - Trade Corridors Enhancement Account (Committed)								Program Code
Existing Funding (\$1,000s)									20.30.210.320
Component	Prior	23-24	24-25	25-26	26-27	27-28	28-29+	Total	Funding Agency
E&P (PA&ED)									San Bernardino County Transportatic TCEP Regional funds Program Code: 20.30.210.320
PS&E									
R/W SUP (CT)									
CON SUP (CT)									
R/W									
CON									
TOTAL									
Proposed Funding (\$1,000s)									Notes
E&P (PA&ED)									TCEP award totals \$10.543M for the ZE component. \$5.6M is for the Procurement Allocation shown here. The balance of \$4.943M is for the CON Allocation.
PS&E									
R/W SUP (CT)									
CON SUP (CT)									
R/W									
CON				5,600				5,600	
TOTAL				5,600				5,600	

<b>Existing Average Annual Vehicle Volume on Project Segment</b>		<b>9,558</b>					
<b>Existing Average Annual Truck Percent on Project Segment</b>		<b>40.8%</b>					
<b>Estimated Year 20 Average Annual Vehicle Volume on Project Segment with Project</b>		<b>12,876</b>					fehr and peers traffic report (10/4/24) + project description
<b>Estimated Year 20 Average Annual Truck Percent on Project Segment with Project</b>		<b>40.8%</b>					
<b>Measure</b>	<b>Metric</b>	<b>Project Type</b>	<b>Build</b>	<b>Future No Build</b>	<b>Change</b>	<b>Increase / Decrease</b>	
<b>Congestion Reduction (Freight)</b>	Change in Daily Vehicle Hours of Delay	All	35.8	570.2	(534.40)	Decrease	FHWA BIL BIP B/C Analysis
	Change in Daily Truck Hours of Delay	All (except rail)	14.6	232.6	(218.05)	Decrease	
	(Optional) Person Hours of Travel Time Saved	All	-	-	-	-	
	(Optional) Daily Truck Trips Due to Mode Shift	Rail, Sea Port	-	-	-	-	
	(Optional) Daily Truck Miles Travelled Due to Mode Shift	Rail, Sea Port	-	-	-	-	
	(Optional) Other Information	All	-	-	-	-	
<b>Throughput (Freight)</b>	Change in Truck Volume	Highway, road, and port projects only	-	-	-	-	
	Change in Rail Volume	Rail	Not applicable to this project				
	(Optional) Change in Cargo Volume	Sea Port, Airport	Not applicable to this project				
	(Optional) Other Information	All	Not applicable to this project				
<b>Velocity (Freight)</b>	Truck Travel Time Reliability Index ("No Build" Only) (Optional Metric)	National and State Highway System Only	Not applicable to this project				
	(Optional) Other Information	All	Not applicable to this project				
	Travel time or total cargo transport time	All	Data Not Available				
<b>Air Quality</b>	Particulate Matter (PM 10)	All	-	2.8 MT	(2.8 MT)	Decrease	Combined FHWA BIL BIP B/C Analysis + AFLEET CFI Emissions Tool & Cal B/C sketch model
	Particulate Matter (PM 2.5)	All	0.4 MT	6.4 MT	(6.0 MT)	Decrease	
	Carbon Dioxide (CO2)	All	7,290 MT	247,920 MT	(240,630 MT)	Decrease	
	Volatile Organic Compounds (VOC)	All	-	14.3 MT	(14.3 MT)	Decrease	
	Sulphur Oxides (SOx)	All	0.03 MT	1.0 MT	(0.97 MT)	Decrease	
	Carbon Monoxide (CO)	All	-	205.7 MT	(205.7 MT)	Decrease	
	Nitrogen Oxides (NOx)	All	13.9 MT	477.0 MT	(463.1 MT)	Decrease	
<b>Safety</b>	Number of Fatalities	Road and Land	Data Not Available				
	Rate of Fatalities per 100 Million VMT	Port	-	-	-	-	
	Number of Serious Injuries		Data Not Available				
	Number of Serious Injuries per 100 Million VMT	-	-	-	-		
	(Optional) Number of Non-Motorized Fatalities and Non-Motorized Serious Injuries	-	-	-	-		
	(Optional) Other Information	All	-	-	-	-	
<b>Cost Effectiveness</b>	Benefit Cost Ratio	All	3.5	0	3.5	Increase	AVG of FHWA BIL BIP B/C Analysis + WattEV Analysis
	(Optional) Other Information	All	-	-	-	-	
<b>Economic Development</b>	Jobs Created	All	583	0	583	Increase	13 jobs / \$M
	(Optional) Other Information	All	-	-	-	-	

# Baker Boulevard Bridge and Zero-Emission Truck Infrastructure Project – Bridge Component

The following reports are selected portions of the complete documents. Those complete documents can accessed and downloaded with the following links.

## 1. Project Report:

- Bridge Type Selection Report: Baker Boulevard Bridge Over the Mojave River, Existing Br. No. 54C-0127
- [https://sanbagcagov365-my.sharepoint.com/:b:/g/personal/jmejia\\_gosbcta\\_com/EbNmdsLkTqdCnnAARfuV7eUBBVeohjHA3iDfM6kXbyUFOg?e=lgT27r](https://sanbagcagov365-my.sharepoint.com/:b:/g/personal/jmejia_gosbcta_com/EbNmdsLkTqdCnnAARfuV7eUBBVeohjHA3iDfM6kXbyUFOg?e=lgT27r)

## 2. Environmental Document:

- PSR#TD004 Baker Boulevard Bridge Over Mojave River Bridge Replacement: Final Initial Study / Mitigated Negative Declaration, State Clearinghouse# 2025030204
- [https://sanbagcagov365-my.sharepoint.com/:b:/g/personal/jmejia\\_gosbcta\\_com/EZFB4naFUshEnc1V0SUKHU4BZqCaeF1mXlUVSUP-pvsz4w?e=Gg0jeU](https://sanbagcagov365-my.sharepoint.com/:b:/g/personal/jmejia_gosbcta_com/EZFB4naFUshEnc1V0SUKHU4BZqCaeF1mXlUVSUP-pvsz4w?e=Gg0jeU)

**BRIDGE TYPE SELECTION REPORT**  
**BAKER BOULEVARD BRIDGE OVER THE MOJAVE RIVER**  
EXISTING BR. No. 54C-0127



Prepared for:



San Bernardino County  
Department of Public Works

Prepared by:



110 Blue Ravine Road  
Folsom, CA 95630  
(916) 858-0642



OCTOBER 1, 2024

## CONTENTS

1.	Introduction .....	3
2.	Type Selection Recommendations .....	7
3.	Hydraulics / Hydrology .....	9
3.1.	SBC Flood Control District Access Ramp .....	10
4.	Soil Characteristics and Foundation Recommendations .....	11
5.	Approach Roadway Design .....	12
5.1.	Driveway Conforms .....	13
5.2.	Approach Railing .....	13
5.3.	Channel Access Ramp .....	14
6.	Design Specifications .....	15
7.	Construction Considerations .....	15
7.1.	Vertical Clearances and Falsework .....	15
7.2.	Staged Construction and Traffic Control .....	16
7.3.	In-Water Construction .....	16
7.4.	Substructure .....	17
8.	Corrosion .....	17
9.	Project Administration & Permitting .....	17
9.1.	Environmental Permitting .....	18
10.	Hazardous Materials .....	18
11.	Utilities and Existing Features .....	18
12.	Bridge Railing .....	19
13.	Bridge Lighting .....	19
14.	Aesthetics .....	19
15.	Structure Data Table .....	20
16.	Project Funding .....	20
17.	Project Schedule .....	21

## ATTACHMENTS

Attachment A Structure General Plans

Attachment B Structure Alternative Estimates

Attachment C Preliminary Foundation Report

Attachment D Draft Hydrology, Hydraulics and Scour Analysis Report

Attachment E Design Criteria Worksheet

Attachment F County Speed Zone Resolutions

Attachment G SBC Flood Control District ACCESS Ramp Alternatives

Attachment H SBC Board Resolution 2001-125

Attachment I SWITRS Crash Listing, 12/6/2022

## 1. INTRODUCTION

San Bernardino County (County) is proposing to replace the existing two-lane Baker Boulevard Bridge (Bridge No. 54C-0127) over the Mojave River with a four-lane bridge structure to meet current County Policy Map Roadway designation as a Major Arterial Highway to improve safety and operations along the facility (Project). Project Stakeholders include the County, County Flood Control District, Caltrans and the Baker Community Service District.

The bridge is located within the unincorporated community of Baker in San Bernardino County, approximately 600 feet south-west of SR-127 along Baker Boulevard (formerly known as SR-31). The original 90'-0" long bridge constructed in 1931 was subsequently rehabilitated and lengthened, and the associated channel section below excavated and widened in 1939 in response to a 1938 flood event. The current structure is a 408'-0" long, 28'-10" wide, 22-span timber bridge with a reinforced concrete deck and asphalt overlay. Both abutments have a concrete backwall behind timber columns with a concrete cap supporting the timber stringers. Figures 2 and 3 show the project vicinity and location maps.

Per County Road Planning and Design Standards, design speed for a Major Highway in the desert on flat terrain is 60 mph. However, the proposed bridge lies within an established speed zone of 35 mph that takes into consideration Baker Community Services District request, adjoining residential and commercial businesses on both sides along with projected growth and increase in traffic volume. See Attachment H for SBC Board Resolution 2001-125. Baker Boulevard is not designated as a STAA truck route, but there is potential for future designation given the high truck utilization along the route and proximity to Interstate 15 and Highway 127 which is a designated STAA Terminal Access Route. Baker Boulevard is primarily used by trucks and residents to access food, fuel, lodging, and repair services. The 2022 ADT for the bridge is 9,559 vehicles per day and the 2045 projected ADT is 15,074 vehicles per day with 30% truck traffic.

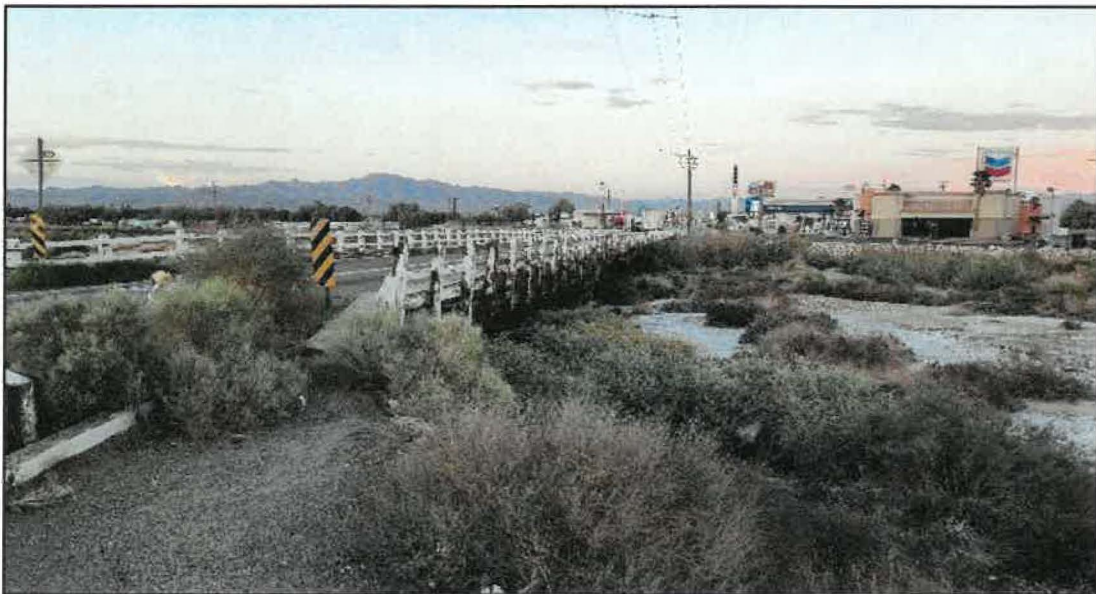

Figure 1: Existing Baker Boulevard Bridge

To facilitate construction, Temporary construction easements are needed outside existing County right-of-way in adjacent privately owned parcels located upstream of the bridge and within County Flood Control District property downstream.

A Draft Hydrology, Hydraulics and Scour Analysis Report was completed (Attachment D) to determine the anticipated flow and water surface elevation for the Q<sub>100</sub> storm event to design the replacement bridge to meet FHWA hydraulic conveyance recommended guidelines.

PA&ED and PS&E are funded through San Bernardino County Transportation Authority (SBCTA) Measure I Major Local Highway Projects (MLHP) funds. Construction will be funded using a combination of MLHP, and Surface Transportation Program (STP) and alternate funds yet to be determined.

The estimated base construction cost is \$17 million. Adding contingencies, construction management and escalation yields a total estimated 2026 construction cost of approximately \$28 Million. Funding identified to be allocated for construction using MLHP and STP funds is currently set at \$15 million. STP Construction funds are programed for FY 25/26 requiring the project to be advertised for construction prior to the end of 2025.

The objective of this Type Selection Report is to obtain consensus for the recommended structure type, span configuration, typical section and vertical profile. Dokken Engineering recommends a **405-ft, 10-span cast-in-placed reinforced slab bridge founded on driven precast pile extensions**. A summary of the anticipated project construction costs for the recommended Project is included in the table below:

**Table 1: Project Construction Costs**

Bridge Construction Costs (w/ Mobilization)	\$ 13,900,000
Roadway Costs (w/ Mobilization)	\$ 3,200,000
<b><i>Subtotal (Base Construction Cost)</i></b>	<b><i>\$ 17,100,000</i></b>
Contingency (25%)	\$ 4,275,000
Construction Management (15%)	\$ 2,565,000
<b>Subtotal Construction Costs</b>	<b>\$ 23,940,000</b>
Escalation (@ 8% for 2-Years)	\$ 3,990,000
<b>Total 2026 Construction Cost</b>	<b>\$27,930,000</b>

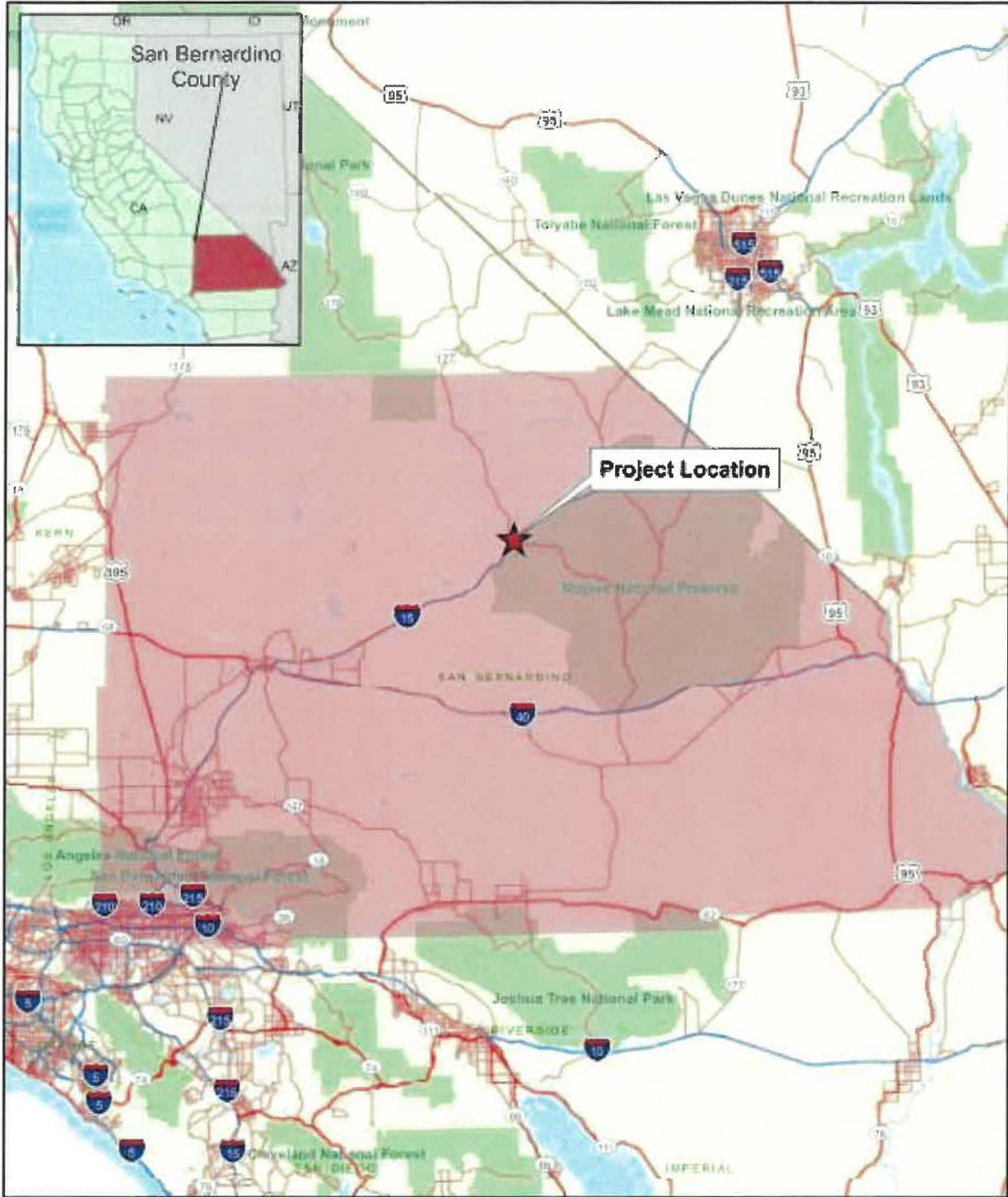

Figure 2: Project Vicinity



Figure 3: Project Location

**2. TYPE SELECTION RECOMMENDATIONS**

Three structure types were considered during the development of this Type Selection Report: Cast-In-Place Reinforced-Concrete (CIP R/C) Slab, Precast-Prestressed (PC-PS) Voided Slabs, and reinforced concrete box culvert. Table 2 summarize the advantages, disadvantages and costs of each structure type considered.

**Table 2: Structure Types Considered**

Alternative	Structure Type	Advantages	Disadvantages	Bridge Construction Cost *
#1	Cast-In-Place Reinforced-Concrete (CIP R/C) Slab	<ul style="list-style-type: none"> <li>• Lowest Construction Cost</li> <li>• Easy to accommodate Stage Construction</li> <li>• Maximum Hydraulic Conveyance</li> </ul>	<ul style="list-style-type: none"> <li>• Construction Time</li> <li>• Requires Falsework</li> </ul>	\$ 17,355,000
#2	Precast-Prestressed (PC-PS) Voided Slabs	<ul style="list-style-type: none"> <li>• Reduced construction time.</li> <li>• Minimal Falsework</li> <li>• Easy to accommodate Stage Construction</li> </ul>	<ul style="list-style-type: none"> <li>• Higher Construction Cost</li> </ul>	\$ 18,634,000
#3	CIP-Reinforced Concrete Box Culvert	<ul style="list-style-type: none"> <li>• Minimal Falsework</li> <li>• Reduced construction time</li> </ul>	<ul style="list-style-type: none"> <li>• Highest Construction Cost</li> <li>• Susceptible to scour</li> <li>• Requires overexcavation and recompaction</li> </ul>	\$ 18,836,000

*\*Cost includes Bridge Removal Mobilization and Contingency, See Attachment B.*

**Structure Type #1 - CIP-R/C slab (Recommended Structure Type)**

The recommended structure type is a CIP-R/C slab based on the low construction cost, low maintenance, and ease of construction. The recommended bridge is 10 spans with a total length of 405'-0" and span lengths of 40'-6". The total width pending selection of combination vehicular barrier and pedestrian railing with sidewalks on the bridge is 96'-4" with four 12'-0" lanes, 12'-0" median, 10'-0" shoulders, and installation of either Caltrans Standard Plan Type 732SW or 85SW barriers. Combination vehicular barrier and pedestrian railings with sidewalks along with the inclusion of tubular hand railing to satisfy bicycle railing height requirements is recommended given established speed zone encompassing the bridge is 35 mph; compliance with MASH (Manual for Assessing Safety Hardware) TL-2 testing levels for cars and trucks having speeds at 44 mph, and California State Department of Transportation, Caltrans, approval of these standards for posted speeds up to 45 mph - ref.: Caltrans 2023 Highway Design Manual Section 208.10 Bridge Barrier and Railings. The bridge deck/structure will be 1'-8" deep based on a minimum depth to span ratio of 0.040.

Both abutment 1 and 2 will be diaphragm type abutments on driven pile foundations. The piers will be Pre-cast/Pre-stressed (PC/PS) pile extensions. A General Plan for the recommended structure type can be found in Attachment A.

A cast-in-place superstructure was selected as the project location is within 90 minutes of several concrete suppliers in Barstow, CA and Las Vegas, NV (Robertsons Ready Mix and Sierra Read Mix).

The recommended structure type, width, and span length is shown in table 3.

Table 3: Recommended Structure Type

Structure	Bridge No.	Width	Length	Comments
Baker Boulevard Bridge	54C-0127	96'-4"	405'-0"	10-Span Reinforced Concrete Slab Bridge

**Structure Type #2 - PC/PS Voided Slab**

The second structure type considered is a precast-prestressed (PC/PS) voided slab bridge with a composite cast-in-place (CIP) deck. With a span length of 40'-6", the total structure depth for this alternative is 1'-10" including both the 1'-4" deep precast slab units with a minimum depth to span (D/S) ratio of 0.03 and a 6" concrete topping slab. The recommended slab type is a type SII48. The PC/PS voided slabs will be constructed offsite, delivered to the project, and erected onto the CIP abutments. After girder erection, the 6" topping slab will be placed to provide transverse continuity and prevent cracking between the girders. The slabs would be designed as simply supported for deadload and continuous for live load. This structure type would minimize the amount of required falsework, but falsework would still be required for bent cap construction.

PC/PS Voided Slabs were not selected due to the increased cost and that the project delivery will not receive a large advantage for accelerated bridge construction since a 2-stage construction is easily accommodated in the site.

**Structure Type #3 - CIP/RC Box Culvert**

The third structure type considered is a cast-in-place reinforced concrete (CIP/RC) box culvert using Caltrans Standard Plans. To meet the minimum hydraulic conveyance requirements, a minimum height of 8ft with 14ft spans are required with a total of 26 cells. The culvert wall height will vary to meet the profile of the road.

To protect the structure from scour, a five to six feet deep cut off will be required. To ensure the soil has the correct bearing pressure resistance, it is recommended to over-excavate and re-compact the upper 4ft of soil due to the loose sands present in the existing channel bed.

The CIP/RC box culvert was not selected due to the high construction cost, extensive channel work, and long construction duration. Additionally, the site may be subject to deep scour which is costly and/or infeasible to address given the shallow foundations of a box culvert system.

### 3. HYDRAULICS / HYDROLOGY

Only extreme Mojave River floods originating in the San Bernardino Mountains result in appreciable flow at the Baker Boulevard Bridge location, due to transmission into the alluvial aquifer along the river's approximate 110-mile (mi) length. Design flows at Afton, CA were evaluated the adjusted based on historical losses between Afton and Silver Lake, located just downstream of Baker, and synthetic hydrographs were developed based on historical flood events. Refer to Attachment D, Draft Hydrology, Hydraulics and Scour Analysis Report for additional information.

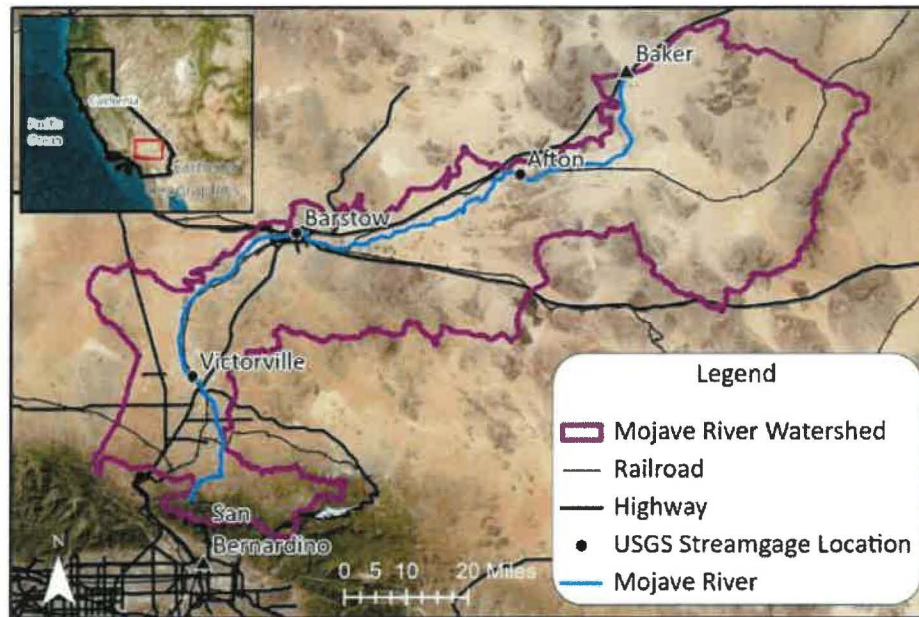

Figure 4: Mojave River Watershed and Key Features

Since the development of the Attachment D Report, additional analysis was performed to correlate known flows at Afton to the observed and documented flow events at Baker Blvd. Specific events include the 1938 event that washed out the 90-ft long 1931 bridge and a 2005 event in which the water surface at Baker approached the soffit of the 408-ft long 1939 bridge. Based on this further analysis, an attenuation and loss of 57% between Afton and Baker was established. After considering this loss, the design flood for the Baker Blvd Bridge has been set to the 100-year return period (85% confidence) which equated to a flow of 8,900 CFS and a water surface elevation = 928.0'. Note, this water surface is based on the post project construction condition and includes 656 CFS overtopping Baker Boulevard southwest of the proposed bridge. In the event of a future project to raise the entirety of Baker Boulevard above the 100-year water surface, this 656 CFS would be forced under the proposed bridge, resulting in a future 100-year water surface elevation = 928.23'. Therefore, the proposed bridge minimum soffit elevation will be set at 928.23'. The figure below shows the water surface for the design flood.

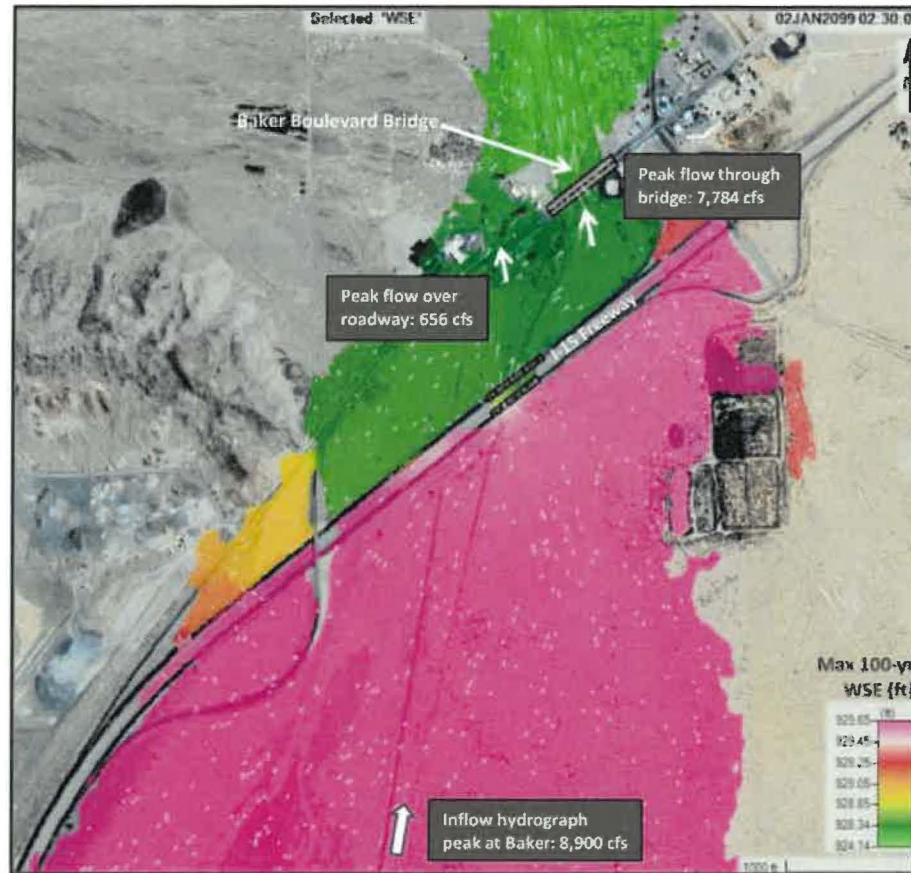

Figure 5: Mojave 100-year (85% Confidence) Water Surface at Baker Blvd (Post Construction Condition)

### 3.1. SBC Flood Control District Access Ramp

The project poses the possibility to construct a SBC Flood Control District ramp downstream of the bridge along the eastern levee for channel maintenance and to facilitate bridge inspection. The ramp, if accommodated, will include the following requirements:

- 24' wide commercial driveway approach from the roadway (Baker Blvd) per SBC current Std Plan 129 (modified to accommodate ADA access requirements within the public right-of-way)
- All-weather surface roadway extending from said approach within SBC FCD R/W
- 50' from the edge of the roadway R/W begin construction of a paved concrete ramp to the invert of the channel.
- Access ramp to the channel invert minimum of 15' wide with grade/slope not to exceed 10% per Detention Basin Design Criteria for SBC, Section 9.
- 20' Dike width alongside/parallel to the access ramp
- 30' long landing lying parallel to the channel embankment at the bottom of the ramp.
- Outside vehicle turning radius of 60' and an inside turning radius of 25' along the maintenance access road and at the terminus of the proposed landing within the channel.
- 15' horizontal access gate opening per SBC FCD SP 209 is 15'.

#### 4. SOIL CHARACTERISTICS AND FOUNDATION RECOMMENDATIONS

Earth Mechanics Inc. (EMI) completed preliminary site observations and prepared a summary of their findings in a Preliminary Foundation Report (PFR) found an Attachment E.

The project area lies within the Mojave Desert, a wedge-shaped region bounded by the right-lateral San Andreas fault system on the southwest, the left-lateral Garlock fault on the north, and the Colorado River on the east. Caught between these fault systems, the Mojave Desert region is undergoing active transgressional deformation and shortening.

Within the central part of the Mojave Desert, most faults are northwest-trending, right-lateral faults. These faults comprise the Eastern California Shear Zone, which allows for the transfer of plate motion between the San Andreas fault system and the Walker Lane Belt. The nearest fault to the project site is the Baker fault. The Baker fault is located approximately 3.5 miles west of the project site.

LOTBs were not available for the existing Baker Boulevard bridge but were available for the nearby West Baker Overcrossing. Based on these LOTBs, the site soils can be expected to be composed predominantly of fine-grained soils consisting of medium stiff to very stiff silt and clay. The fine-grained soils were underlined by dense to very dense coarse-grained soils consisting of sand and gravel. Groundwater is expected to be within 20ft of the riverbed surface.

Shallow and deep foundation types are compared and evaluated below:

- Shallow spread footing foundations are typically recommended when near surface soils are well compacted soil/clay or bedrock and not susceptible to large amounts of scour. Since the predominant soil type is anticipated to be fine-grained soils with deep scour, **spread footings are not recommended.**
- Due to the inability of using shallow foundations, Deep foundations must be considered:
  - **CIDH piles are not recommended** due to construction challenges associated with the anticipated high groundwater and the silty/sandy material. Groundwater would require the contractor to place the piles under slurry and the silty/sandy material would require temporary casing. Both would increase the construction cost and duration.
  - **Driven pile extensions are recommended for the Baker Boulevard Bridge replacement project.** Either PC/PS or steel pile extensions may be used. By using driven piles, the contractor does not have to mobilize extensive equipment/tools to facilitate drilling into silty/sandy soil with groundwater.

AASHTO Bridge Design Specifications require that the driven pile extension be placed below the total scour depth as shown in the figure below.

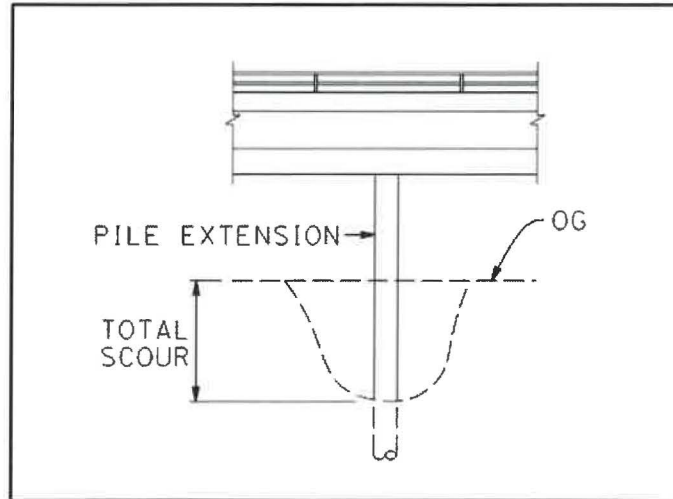

Figure 6: Pile Extensions in Scourable Material

Based on the bridge design criteria and calculated scour (from Section 3.2), **the recommended foundation types for both the abutments and piers to be supported with driven pile extensions.**

## 5. APPROACH ROADWAY DESIGN

Baker Boulevard is classified as a Major Highway with an Average Daily Traffic (ADT) of 9,559 (measured in 2022) and an expected future (2045) ADT of 15,074. Truck makes up 30% of the total vehicles.

San Bernardino County Standards and the Caltrans Highway Design Manual, the roadway section consists of the following:

- Four 12'-0" Lanes (2 in each direction)
- One 12'-0" Striped Median
- Two 10'-0" Shoulders
- Two 6'-2" Sidewalks
- Total approach roadway cross section width will be 92'-4".

AASHTO's A Policy of Geometric Design of Highways and Streets and San Bernardino County standards are being used for the design of the roadway approaches. Dokken prepared the proposed Project Design Criteria Worksheet included as Attachment E. Baker Boulevard in its ultimate configuration is classified as a Major Highway. Per San Bernardino County Desert Design Guidelines, a design speed of 60 mph is identified for flat terrain. However, AASHTO discusses that on rural higher speed roads it is appropriate to have a speed reduction/transition zone approaching smaller towns and communities. San Bernardino County also passed a resolution in 2001 to establish a 35 mph speed zone on Baker Blvd through the project vicinity. Additionally, the California MUTCD and CVC Section 22358.8 provide additional justification for retaining the existing 35 MPH posted speed limit. The County Speed Zone Resolutions are included in Attachment F. The profile of the roadway is being raised approximately 1.5 feet at the bridge location to permit passage of the 1 percent

probability flood, 100-year event, within the channel section below without freeboard - ref.: 2023 Caltrans Highway Design Manual Section 821.3 Selection of Design Flood. To maintain geometric consistency, the vertical profile element of the roadway will comply where feasible with the minimum design speed denoted in the San Bernardino County Desert Design Guidelines for a Major Highway.

The existing bridge is a flat profile, however the proposed replacement bridge will include a vertical with a highpoint at the center of the bridge to provide slopes for positive surface drainage.

### **5.1. Driveway Conforms**

Immediately east of the bridge on the south side of Baker Blvd there is a commercial center with a Taco Bell and Chevron gas station. The two driveways accessing this center will require reconstruction as the proposed approaches will be above existing grade. The Taco Bell driveway has the most significant grade difference as it is the first driveway off the bridge and the profile has not yet conformed to the existing grade. This first driveway will be conformed with grades less than 10%, likely 6-8% max. The second driveway, accessing the Chevron is located much closer to the vertical conform and will be designed with grades of 5% or less. Between these two driveways, immediately behind the existing sidewalk there is a large concrete pad within the gas station lot. This area appears to be used for additional parking and potentially turning and maneuvering of the gas trucks refilling the station's tanks. In order to maintain this area at the same grade as the existing lot, a retaining curb along the back of proposed walk will be utilized. This retaining curb would be less than 1 foot in height, but will likely require a pedestrian railing or at the very least a detection curb.

Prior to 65% design, truck turns will be run at the gas station driveway and lot to confirm that the gas tanker trucks will still be able to access the stations tanks. Dokken will also work with the County to contact the station to confirm how exactly trucks access the existing tanks.

### **5.2. Approach Railing**

For the posted speed/established speed zone of 35 mph, sufficient Clear Recovery Area meeting AASHTO recommended guidelines exist to justify non-inclusion of approach railing. Accident data also does not identify need at this location - ref. Attachment I SWITRS Crash Listing, 12/06/2022. In addition, site conditions restrict inclusion of approach railing without significant modification to standards and/or deviation in standard application. To accommodate a design speed of 60 mph, a design exception for Length of Need will be required at the northeast corner of the bridge, the westbound approach. The full length of need of railing cannot be provided due to the location of the SBC Flood Control District maintenance access driveway. The location of the access driveway has been pushed as far east as possible while still staying within the County's right of way. The standard 25 foot transition railing and a standard terminal system can be provided prior to the levee access driveway, however there is not adequate space for the additional length or railing required to satisfy the length of need requirement. In addition, special attention needs to be given to structure approach railing placed behind concrete curb. When vehicles strike a curb that can vault off the pavement and change the position of impact to the approach railing. For this

reason it is not advisable to have approach railing behind sidewalk unless the modified curb shape shown in figure below is used. There could be precedence to remove the approach railing or use a shorter nonstandard system as AASHTO Roadside Design Guide states that guardrailing should be used with curb heights of no more than 4 inches high, but only if the guardrail is flush to the curb. If the guard rail is not flush to the curb than it should have a minimum offset of 13 feet form the curb face.

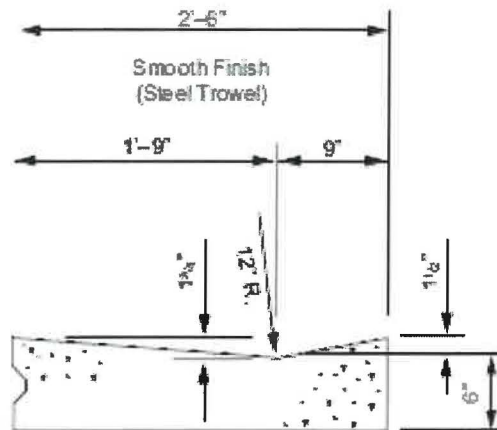

Figure 7: Laydown Curb required for use offset from approach guard railing

### 5.3. Channel Access Ramp

Construction of an access ramp to the channel invert would facilitate maintenance and inspection efforts of the San Bernardino Flood Control District and that of San Bernardino County Transportation for the bridge. Downstream access can be provided on the east side of the channel from a driveway on the westbound side of the road. Access Ramp design options which match the Flood Control District's standards are included in Attachment G. Due to the skew of the channel pushing the ramp further towards the private property parcel lines, constructing the ramp such that the required landing is within the toe of the channel bank, i.e. outside of the channel bottom, would only be possible if a retaining wall were constructed between the access ramp and the top of dike or the approach railing depicted is eliminated with proposed driveway from the roadway moved closer to the bridge abutment. Alternatively, Placing the landing within the channel bottom provides adequate offset between the top of dike and the landing to construct 2h:1v slope.

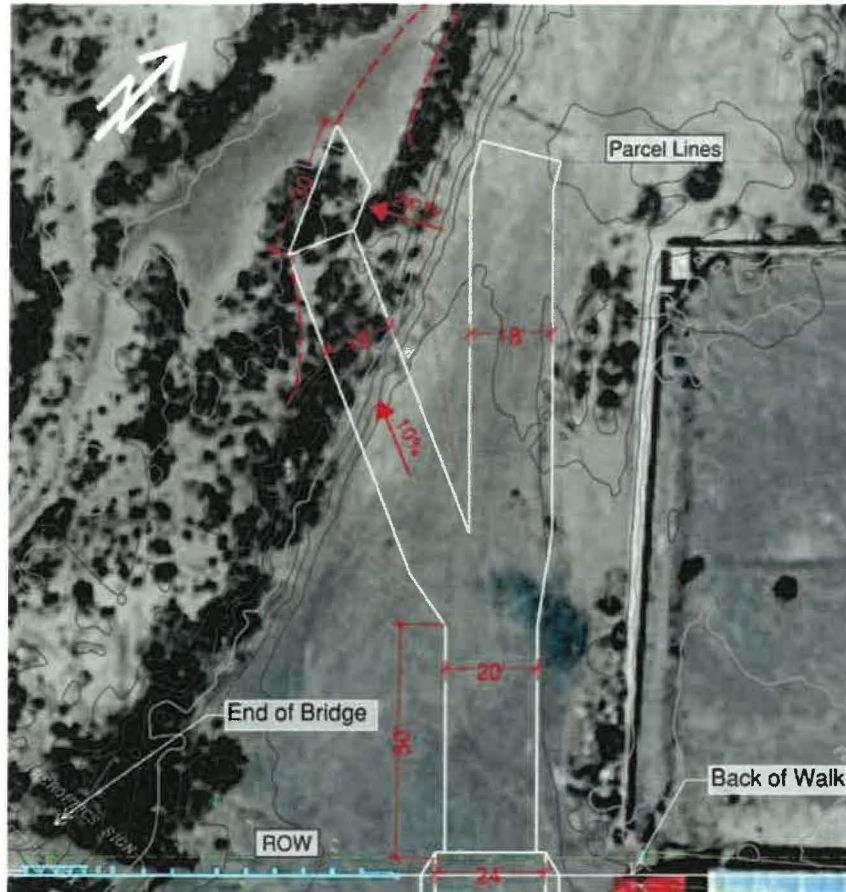

Figure 8: Proposed Channel Access Ramp

## 6. DESIGN SPECIFICATIONS

Design of the Baker Boulevard Bridge Replacement Project will be in conformance with:

- San Bernardino County Standards
- San Bernardino County Flood Control District Standards
- AASHTO LRFD Bridge Design Specifications (8th Edition, 2017)
- Caltrans Amendments to the 8th Edition AASHTO LRFD Bridge Design Specifications
- Caltrans Seismic Design Criteria (Version 2.0, dated April 2019, with October 2019 Interim Revisions)
- Caltrans Highway Design Manual (HDM)
- AASHTO Roadside Design Guide
- Caltrans Traffic Safety Systems Guidance, March 2019

## 7. CONSTRUCTION CONSIDERATIONS

### 7.1. Vertical Clearances and Falsework

The recommended alternative utilizes cast in place concrete and will require the installation of temporary falsework. Since the Baker Bridge does not cross over any pedestrian,

vehicular, or railroad traffic, the only horizontal and vertical falsework restrictions will be to allow for the passage of river flows.

## 7.2. Staged Construction and Traffic Control

The new Baker Bridge will be constructed on the same alignment as the existing structure requiring staged construction. It's anticipated that the new structure can be constructed in three stages. Stage 1 will construct a new structure to the North of the existing structure. In Stage 2, traffic will be diverted on the newly built portions of the structure, allowing the contractor to remove the existing bridge and construct the remaining section of the Baker Boulevard. Stage 3 will construct the remaining traffic barrier.

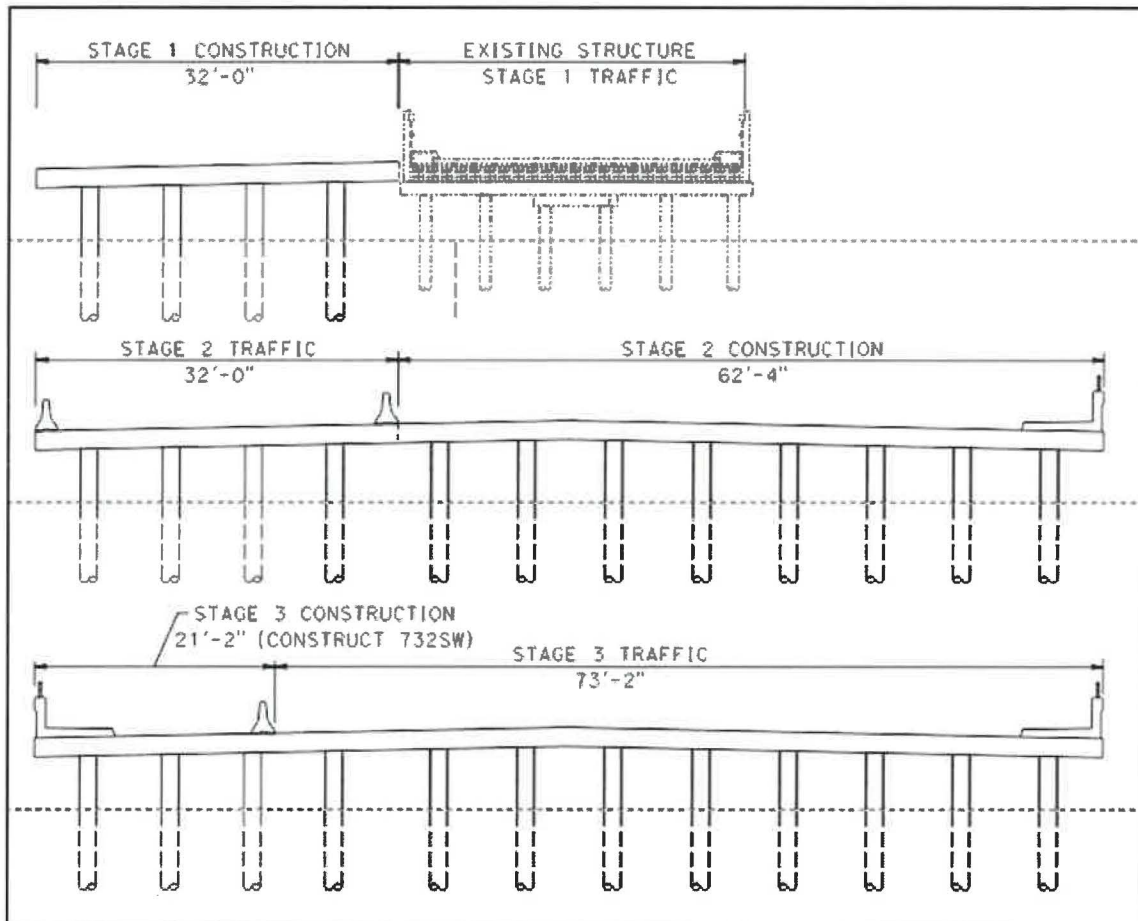

Figure 9: Staged Construction

## 7.3. In-Water Construction

It is anticipated that the Mojave River Channel will be dry during the duration of the construction, but if there is any water flowing through the construction area it will be handled with a temporary creek diversion system. Sandbags will be used to divert roadway surface run-off to the channel keeping the surrounding work areas dry.

#### 7.4. Substructure

**Abutments** Given the low profile of the bridge and recommended CIP R/C slab, diaphragm type abutments are recommended.

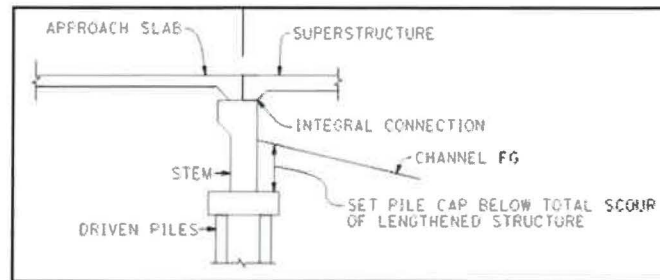

Figure 10: Abutment Details

**Piers** The piers will be driven PC/PS pile extensions connected to the superstructure with integral connections.

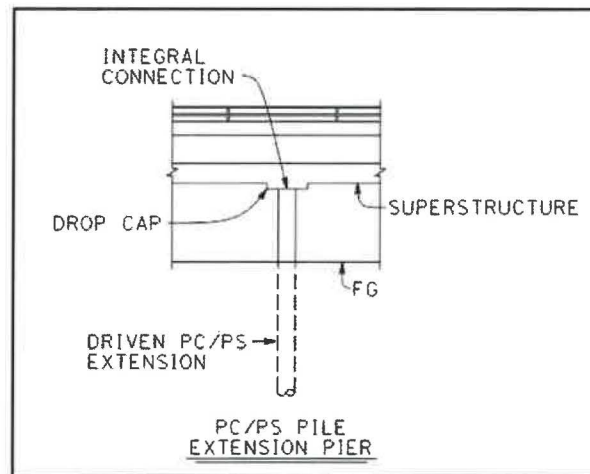

Figure 9: Pier Details

## 8. CORROSION

According to the Caltrans Corrosion Guidelines, soils are considered corrosive if the pH is 5.5 or less, or chloride content is 500 parts per million (ppm) or greater, or sulfate content is 1,500 ppm or greater. No corrosion data was available at the time of this report. Based on the LOTB of nearby structures, the predominant material in the area is Clay which tends to be corrosive. The corrosive nature of the soil will be determined after site-specific borings are completed. If determined to be corrosive, appropriate mitigation measures will be used which typically include increased concrete cover or coated reinforcement.

## 9. PROJECT ADMINISTRATION & PERMITTING

The County will oversee the contract administration, advertisement, and award for this project.

### 9.1. Environmental Permitting

Avoidance, minimization, and/or mitigation measures outlined in the Initial Study with Proposed Mitigated Negative Declaration will be implemented. Prior to construction, the following environmental permits will be required:

- Section 401 Water Quality Certification from the Lahontan Regional Water Quality Control Board
- Section 1602 Streambed Alteration Agreement from the California Department of Fish and Wildlife

Note, a Section 404 Permit is not required for the project as the U.S. Army Corps of Engineers does not have jurisdiction within the project limits.

## 10. HAZARDOUS MATERIALS

A Phase I Hazardous Waste Initial Assessment (ISA) will be developed for the project. Based on the findings of this assessment, a Phase II assessment will then be completed. It is anticipated that the following hazardous wastes are within the project area:

- Lead Containing Paint within the existing traffic stripes.
- Asbestos in the bearing pads of the existing structure.
- Aerially Deposited Lead (ADL) due to its high ADT and proximity to gas stations.

## 11. UTILITIES AND EXISTING FEATURES

The following utilities and signage will require relocation, refer to Attachment A for locations relative to the proposed bridge:

- SCE Overhead Powerlines
- Telecommunications Lines (attached to the existing structure)
- Water Line (attached to the existing structure)
- Chevron and Taco Bell Signage
- Irrigation Lines
- Fire Hydrant



Figure 10: Utilities and Signage requiring relocation.

## 12. BRIDGE RAILING

As discussed in Section 5, the posted speed/established speed zone is 35 MPH. Based on the posted speed and proposed roadway section, a MASH approved Test Level 2 combination sidewalk and barrier system with a minimum height of 42" for cyclist protection is recommended.

Both the Type 732SW and Type 85SW concrete barrier systems from the 2023 Caltrans Standard Plans meet these requirements. The 85SW is recommended primarily for aesthetics and is included the Structure General Plans in Attachment A.

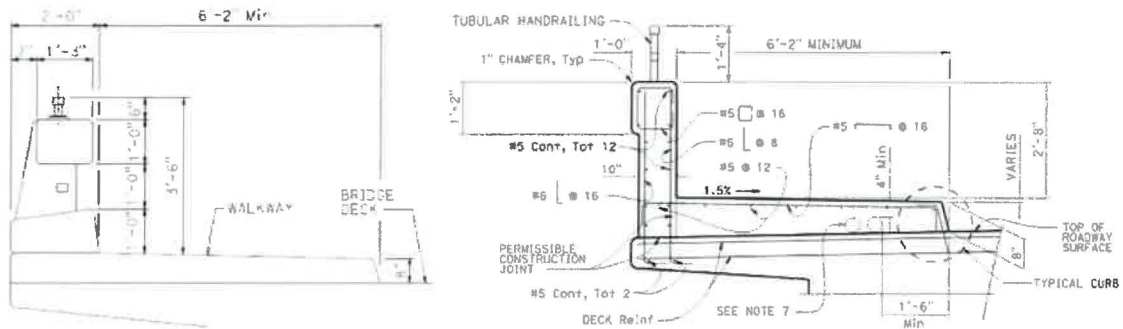

Figure 13: Concrete Barrier Type 85SW (Left) and Type 732SW (Right) Typical Section

## 13. BRIDGE LIGHTING

According to the AASHTO Roadway Lighting Guide, "It may be desirable to provide fixed source lighting on long bridges in urban and suburban areas even though the approaches are not lighted. On bridges without full shoulder, lighting enhances both safety and utility of the bridges. Where bridges are provided with sidewalks for pedestrian movements, lighting is warranted for pedestrian safety and policing."

For this reason and the existing lighting along Baker Blvd adjacent to the bridge, bridge lighting is proposed. The Structure General Plans in attachment A include luminaires on each edge of the bridge deck at an approximate spacing of 200' and alternating between upstream and downstream edge of deck. This spacing is based on standard lighting spacing for Major Highways and will provide adequate light to comply with the requirements of ANSI/IES RP-8, *Recommended Practice for Lighting Roadway and Parking Facilities*.

## 14. AESTHETICS

The recommended structure type, a cast-in-place reinforced concrete slab, can easily incorporate various architectural treatments including form liners, veneers, stains, and integrally colored concrete.

### 15. STRUCTURE DATA TABLE

The following table summarizes the design features that will be included with recommended alternative:

**Table 4: Structure Data Table**

Structure Type	Cast-In-Place Reinforced Concrete Slab
Spans	10 Spans (40'-6" Each)
Structure Depth	1'-8"
Abutments	Diaphragm Type
Construction Sequence	<p>Stage 1 (North Side of Bridge):</p> <p>Excavate and construct abutment footings.                  Construct abutment stems.                  Place falsework &amp; forms for slab                  Pour Concrete.                  Place Barriers and construct approach roadway.                  Move traffic to new alignment and bridge.</p> <p>Stage 2 (Demo Existing Bridge and Construct Remaining Portion)</p> <p>Remove existing bridge.                  Excavate and construct abutment footings.                  Construct abutment stems.                  Place falsework &amp; forms for slab                  Pour Concrete.                  Place Barriers and construct approach roadway.                  Grade channel and place RSP.</p>
Freeboard Requirements	2'-0" over 50-year flood and clear 100-year flood
Vertical Clearance	Controlled by Freeboard
Barriers	Type 732SW or 85SW
Slope Paving	None
Deck Protection	N/A
Temperature Range	10° F to 80° F per AASHTO LRFD Section 3.12.2.1
Joints	Type B Joint Seal @ Hinge, MR = 1½"
Utilities	Relocated Telecommunication Lines (in new sidewalk); Relocated Waterline (mounted to bridge preferred, optional buried below channel bed); Relocated Overhead Electrical (in bridge deck preferred, optional buried below channel bed or overhead)

### 16. PROJECT FUNDING

The Project Approval, Environmental Document and Final Design phases are funded by SBCTA Measure I Major Local Highway Project (MLHP). Funding for construction has been programmed for fiscal year 25/26 with a combination of Measure I MLHP and STP funding and funds yet to be determined. Due to STP funding appropriation constraints, construction funds must be obligated in FY 2025/2026 requiring advertisement prior to December 31, 2025 to award the construction contract by July 2026. Based on the current cost estimate, additional funds will be required to construct the project. See project funding summary table below.

Table 5: Project Funding Summary

Funding	Phase				Total
	PA/ED	PS&E	ROW	CON	
Measure I	\$1,000,000	\$865,000	-	\$5,512,000	\$7,377,000
STP	-	-	-	\$9,561,000	\$9,561,000
Other (TBD)	-	-	-	\$2,027,000	\$2,027,000
<b>Total</b>	<b>\$1,000,000</b>	<b>\$865,000</b>	<b>-</b>	<b>\$17,100,000</b>	<b>\$18,965,000</b>

**17. PROJECT SCHEDULE**

Based on the funding timeline discussed in the previous section, the project must be ready to bid by the end of 2025. The design team has committed to the following project milestones:

Table 6: Project Milestones

Environmental Document	Environmental Permitting	Final Design	Right of Way	Construction Advertisement
July 2025	November 2025	November 2025	November 2025	December 2025

**ATTACHMENT A**  
STRUCTURE GENERAL  
PLANS

5+40.93 POT Elev = 927.40 0.30%	7+43.00 BVC Elev = 928.01	8+93.00 EVC Elev = 929.41 140.00' VC 1.69%	8+95.50 BVC Elev = 929.45 595.00' VC R/C = -0.4840% PER STA	14+80.50 EVC Elev = 930.94 -1.19%	14+86.00 BVC Elev = 930.94 300.00' VC R/C = 0.9233% PER STA	17+86.00 EVC Elev = 931.47 1.58%
---------------------------------------	------------------------------	---	--	---	--	--

**PROFILE GRADE**  
NO SCALE

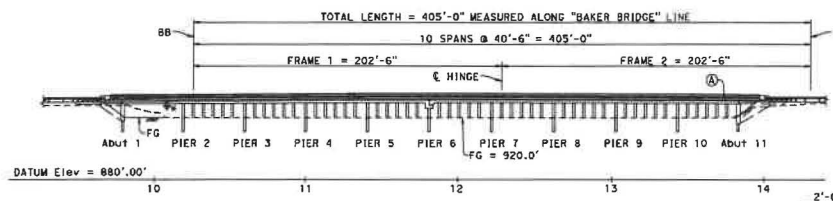

**ELEVATION**  
1" = 30'

\* DESIGN FLOOD = 100-YEAR RETURN PERIOD (85% CONFIDENCE)  
WATER SURFACE = 927.70', Q = 8,900 CFS

Minimum Proposed Soffit Elev = 928.11'  
Exist Soffit Elev = 927.10'  
FG = 920.0'

- LEGEND:**
- (A) Concrete Barrier Type 855W
  - (B) Structure Approach Type N (30) (89-1)
  - (C) 18" Precast Prestressed Concrete Pile (82-2)
  - (D) Cast-In-Place Reinforced Concrete Slab
  - (E) MGS Barrier
  - (F) Bridge Removal (Br. No. 54C0127)
  - (G) Luminaire
  - (H) Optional SBC Flood Control District Access Ramp
  - (I) Reconfigure Existing Driveway/Parking Lot

Dist:	COUNTY:	ROUTE:	SHEET NO.:	TOTAL SHEETS:
08	SBE	-	N/O	1 3

REGISTERED CIVIL ENGINEER DATE: \_\_\_\_\_

PLANS APPROVAL DATE: \_\_\_\_\_

THE STATE OF CALIFORNIA OR ITS OFFICERS OR AGENTS SHALL NOT BE RESPONSIBLE FOR THE ACCURACY OR COMPLETENESS OF SCANNED COPIES OF THIS PLAN SHEET.

DOCKEN ENGINEERING  
110 BLUE HAVEN ROAD, SUITE 200  
FOLSOM, CA 95630

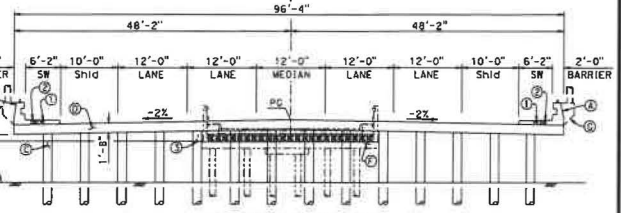

**TYPICAL SECTION**  
1/4" = 1'-0"

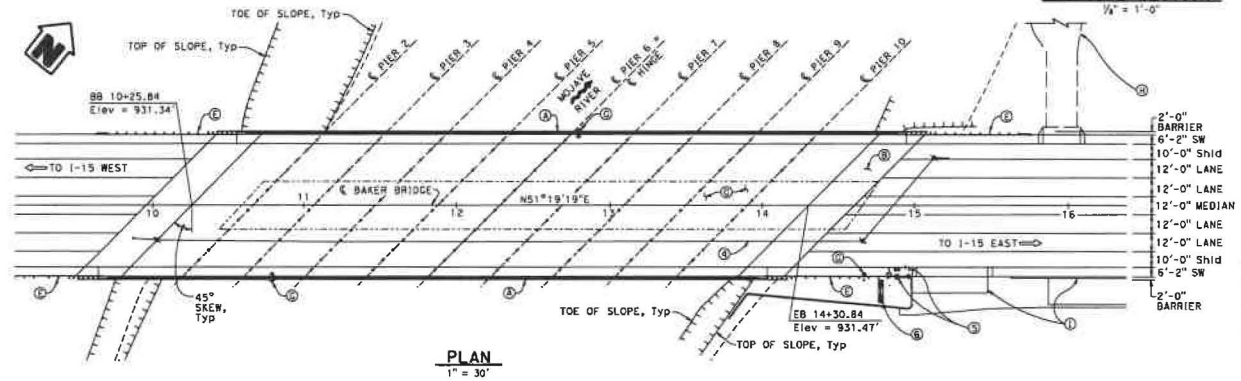

**PLAN**  
1" = 30'

- UTILITIES LEGEND:**
- (1) 2-4"  $\phi$  FUTURE
  - (2) 2-6"  $\phi$  TELECOM
  - (3) Exist WATERLINE (TO BE RELOCATED)
  - (4) Exist OH ELECTRICAL (TO BE RELOCATED)
  - (5) Exist WATER VALVE AND HYDRANT (TO BE RELOCATED)
  - (6) Exist SIGN (TO BE RELOCATED)

DESIGN: J. MOTTMAEL	CHECKED: J. MOTTMAEL	DATE PLOTTED: 11/11/11	PROJECT NUMBER & PHASE: XXXX
DETAILS: T. JANG	PLANNED: J. MOTTMAEL	TIME PLOTTED: 11:45 AM	COUNTY/ROUTE: LOC
QUANTITIES: C	DESIGNED: J. MOTTMAEL	DATE PLOTTED: 11/11/11	CONTRACT NO.: XXXX

PREPARED FOR: **SAN BERNARDINO COUNTY DEPARTMENT OF PUBLIC WORKS**

PROJECT ENGINEER: **J. MOTTMAEL**

**BAKER BRIDGE GENERAL PLAN - ALTERNATIVE 1**

5+40.93 POT Elev = 927.40 0.30%	7+43.00 BVC Elev = 928.01 140.00' VC R/C = 0.9929% PER Sfo	8+83.00 EVC Elev = 929.41 1.69%	8+85.90 BVC Elev = 929.45 399.00' VC R/C = -0.4840% PER Sfo	14+80.50 EVC Elev = 930.94 -1.19%	14+86.00 BVC Elev = 930.94 300.00' VC R/C = 0.9233% PER Sfo	17+86.00 EVC Elev = 931.47 1.58%
---------------------------------------	---	---------------------------------------	--	---	--	--

**PROFILE GRADE**  
NO SCALE

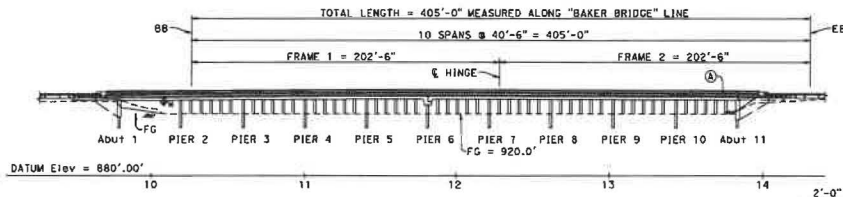

**ELEVATION**  
1" = 30'

\* DESIGN FLOOD = 100-YEAR RETURN PERIOD (85% CONFIDENCE)  
WATER SURFACE = 927.70', Q = 8,900 CFS

**LEGEND:**

- (A) Concrete Barrier Type 655W
- (B) Structure Approach Type N (30) (88-1)
- (C) 18" Precast Prestressed Concrete Pile (82-3)
- (D) Precast/Prestressed Slab Units
- (E) MGS Barrier
- (F) Bridge Removal (Br. No. 54CD127)
- (G) Luminaire
- (H) Optional SBC Flood Control District Access Ramp
- (I) Reconfigure Existing Driveway/Parking Lot

DATE	COUNTY	ROUTE	TOTAL PROJECT	SHEET NO.	TOTAL SHEETS
08	SBC	-	N/A	2	3

REGISTERED CIVIL ENGINEER \_\_\_\_\_ DATE \_\_\_\_\_

PLANS APPROVAL DATE \_\_\_\_\_

THE STATE OF CALIFORNIA BY ITS OFFICERS OR AGENTS  
HEREIN, HAS REVIEWED THESE PLANS FOR THE ACCURACY OF  
COMPLETENESS OF SCALING COPIES OF THIS PLAN SHEET.

DOCKEN ENGINEERING  
110 BLUE RAFTING ROAD, SUITE 200  
FOLSOM, CA 95630

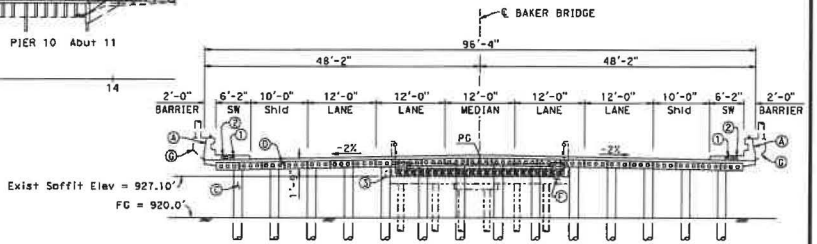

**TYPICAL SECTION**  
1/4" = 1'-0"

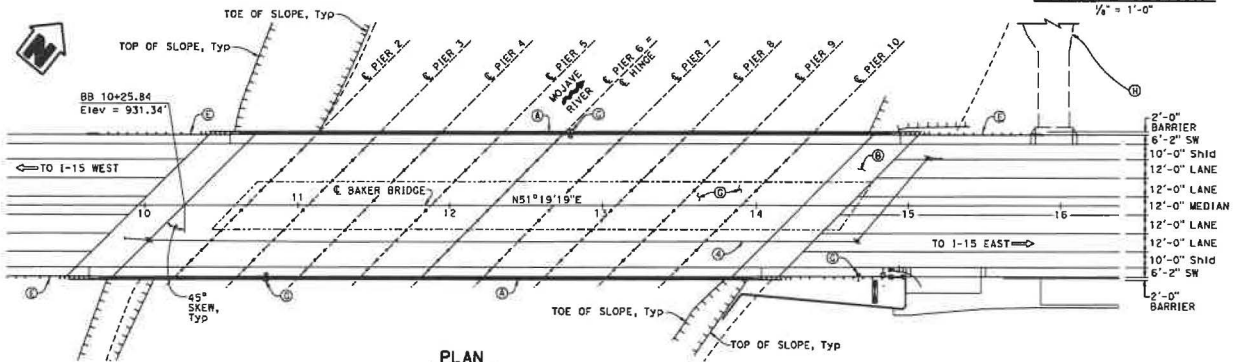

**PLAN**  
1" = 30'

DESIGN	J. MOTTINDEL	CHECKED	J. MOTTINDEL	DATE PLOTTED	01/14/11	FILE	01/14/11	PREPARED FOR	SAN BERNARDINO COUNTY	PROJECT ENGINEER	J. MOTTINDEL	PROJECT NUMBER & PHASE	XXXX	COUNTY/ROUTE	LOC	CONTRACT NO.	XXXX	STANDARD PRINTS BEARING	EARLIER REVISIONS	SHEET	2	OF	3
--------	--------------	---------	--------------	--------------	----------	------	----------	--------------	-----------------------	------------------	--------------	------------------------	------	--------------	-----	--------------	------	-------------------------	-------------------	-------	---	----	---



**ATTACHMENT B**  
STRUCTURE ALTERNATIVE  
ESTIMATES

GENERAL PLAN ESTIMATE

ADVANCE PLANNING ESTIMATE

Revised - December 3, 2007

RCVD BY: \_\_\_\_\_

IN EST: \_\_\_\_\_

OUT EST: \_\_\_\_\_

BRIDGE: Baker Bridge Replacement  
TYPE: Reinforced Concrete Slab (CIP)  
ALT: Alternative #1

BR. No.: 05C0193

DISTRICT: 08  
RTE: Loc  
CO: San Bernardino  
PM: \_\_\_\_\_

BRIDGE LENGTH: 405.00      WIDTH: 96.33      AREA (SF)= 39,014

DESIGN SECTION: Dokken  
# OF STRUCTURES IN PROJECT : 1  
PRICES BY : J. Nottnagel  
PRICES CHECKED BY : R. Burns  
QUANTITIES BY: M. Hendry

EST. NO.  
COST INDEX:  
DATE: 3/30/2024

Item No.	CONTRACT ITEMS	TYPE	UNIT	QUANTITY	UNIT PRICE	AMOUNT
157550	BRIDGE REMOVAL		LS	1	\$312,000.00	\$312,000.00
192003	STRUCTURE EXCAVATION (BRIDGE)	(F)	CY	210	\$100.00	\$21,000.00
193003	STRUCTURE BACKFILL (BRIDGE)	(F)	CY	210	\$100.00	\$21,000.00
490738	FURNISH PILING (CLASS 140)		LF	7,560	\$100.00	\$756,000.00
490739	DRIVE PILE (CLASS 140)		EA	198	\$2,500.00	\$495,000.00
510053	STRUCTURAL CONCRETE, BRIDGE	(F)	CY	550	\$1,750.00	\$962,500.00
510054	STRUCTURAL CONCRETE, BRIDGE (POLYMER FIBER)	(F)	CY	2,410	\$1,850.00	\$4,458,500.00
510080	STRUCTURAL CONCRETE, APPROACH SLAB	(F)	CY	379	\$2,500.00	\$947,500.00
519081	JOINT SEAL	(F)	LF	409	\$200.00	\$81,738.72
520102	BAR REINFORCING STEEL (BRIDGE)	(P)(F)	LB	1,325,185	\$3.00	\$3,975,554.92
	TYPE 85SW	(F)	LF	930	\$500.00	\$465,000.00
999990	MOBILIZATION (10%)		LS	1	\$1,388,430.00	\$1,388,430.00

SUBTOTAL (BRIDGE)	\$13,884,300
25% Contingency	\$3,471,075
<b>TOTAL COST</b>	<b>\$17,355,000</b>
\$ PER FT <sup>2</sup> (BRIDGE)*	\$347.88

\*Not including Bridge Removal

**Escalated Budget Estimate to Midpoint of Construction \***

Escalation Rate per Year 8.0%

\* Escalated budget estimate is provided for information only, actual construction costs may vary. Escalated budget estimates provided do not replace Departmental policy to update cost estimates annually.

Years Beyond Midpoint	Escalated Budget Est.
1	\$18,743,000
2	\$20,242,000
3	\$21,861,000

Years Beyond Midpoint	Escalated Budget Est.
4	\$23,610,000
5	\$25,499,000

GENERAL PLAN ESTIMATE

ADVANCE PLANNING ESTIMATE

Revised - December 3, 2007

RCVD BY: \_\_\_\_\_

IN EST: \_\_\_\_\_

OUT EST: \_\_\_\_\_

BRIDGE: Baker Bridge Replacement  
TYPE: Precast Voided Slab  
ALT: Alternative #2

BR. No.: 05C0193

DISTRICT: 08  
RTE: Loc  
CO: San Bernardino  
PM: \_\_\_\_\_

BRIDGE LENGTH: 405.00      WIDTH: 96.33      AREA (SF)= 39,014

DESIGN SECTION: Dokken  
# OF STRUCTURES IN PROJECT : 1  
PRICES BY : J. Nottengel  
PRICES CHECKED BY : R. Burns  
QUANTITIES BY: M. Hendry

EST. NO.  
COST INDEX:  
DATE: 3/30/2024

Item No.	CONTRACT ITEMS	TYPE	UNIT	QUANTITY	UNIT PRICE	AMOUNT
157550	BRIDGE REMOVAL		LS	1	\$312,000.00	\$312,000.00
192003	STRUCTURE EXCAVATION (BRIDGE)	(F)	CY	210	\$100.00	\$21,000.00
193003	STRUCTURE BACKFILL (BRIDGE)	(F)	CY	210	\$100.00	\$21,000.00
490738	FURNISH PILING (CLASS 140)		LF	7,560	\$100.00	\$756,000.00
490739	DRIVE PILE (CLASS 140)		EA	198	\$2,500.00	\$495,000.00
510053	STRUCTURAL CONCRETE, BRIDGE	(F)	CY	540	\$1,750.00	\$945,000.00
510054	STRUCTURAL CONCRETE, BRIDGE (POLYMER FIBER)	(F)	CY	730	\$1,850.00	\$1,350,500.00
510080	STRUCTURAL CONCRETE, APPROACH SLAB	(F)	CY	371	\$2,500.00	\$927,500.00
	FURNISH PRECAST PRESTRESSED CONCRETE DECK UNIT		SQFT	39,014	\$100.00	\$3,901,365.00
512510	ERECT PRECAST PRESTRESSED CONCRETE DECK UNIT		EA	230	\$9,000.00	\$2,070,000.00
519081	JOINT SEAL	(F)	LF	409	\$200.00	\$81,738.72
520102	BAR REINFORCING STEEL (BRIDGE)	(F)	LB	690,025	\$3.00	\$2,070,074.16
	TYPE 85SW	(F)	LF	930	\$500.00	\$465,000.00
999990	MOBILIZATION (10%)		LS	1	\$1,490,690.00	\$1,490,690.00

SUBTOTAL (BRIDGE)	\$14,906,900
25% Contingency	\$3,726,725
<b>TOTAL COST</b>	<b>\$18,634,000</b>
\$ PER FT* (BRIDGE)*	\$374.10

\*Not including RSP and Bridge Removal

**Escalated Budget Estimate to Midpoint of Construction \***  
Escalation Rate per Year 8.0%

\* Escalated budget estimate is provided for information only, actual construction costs may vary. Escalated budget estimates provided do not replace Departmental policy to update cost estimates annually.

Years Beyond Midpoint	Escalated Budget Est.
1	\$20,125,000
2	\$21,735,000
3	\$23,474,000

Years Beyond Midpoint	Escalated Budget Est.
4	\$25,352,000
5	\$27,380,000

GENERAL PLAN ESTIMATE

ADVANCE PLANNING ESTIMATE

Revised - December 3, 2007

RCVD BY: \_\_\_\_\_

IN EST: \_\_\_\_\_

OUT EST: \_\_\_\_\_

BRIDGE: Baker Bridge Replacement BR. No.: 05C0193

TYPE: CIP Box Culvert

ALT: Alternative #3

DISTRICT: 08

RTE: Loc

CO: San Bernardino

PM: \_\_\_\_\_

BRIDGE LENGTH: 376.00 WIDTH: 96.33 AREA (SF)= 36,220

DESIGN SECTION: Dokken

# OF STRUCTURES IN PROJECT : 1

PRICES BY : J. Nottnagel

PRICES CHECKED BY : R. Burns

QUANTITIES BY: M. Hendry

EST. NO.

COST INDEX:

DATE: 3/30/2024

Item No.	CONTRACT ITEMS	TYPE	UNIT	QUANTITY	UNIT PRICE	AMOUNT
157550	BRIDGE REMOVAL		LS	1	\$312,000.00	\$312,000.00
192003A	OVEREXCAVATION AND BACKFILL	(F)	CY	8,214	\$150.00	\$1,232,135.45
192025	STRUCTURE EXCAVATION (TYPE D)	(F)	CY	47	\$500.00	\$23,703.70
193004	STRUCTURE BACKFILL (CULVERT)	(F)	CY	710	\$250.00	\$177,500.00
510090	STRUCTURAL CONCRETE, CULVERT	(F)	CY	4,870	\$1,750.00	\$8,522,500.00
510080	STRUCTURAL CONCRETE, APPROACH SLAB	(F)	CY	379	\$2,500.00	\$947,500.00
519081	JOINT SEAL	(F)	LF	409	\$200.00	\$81,738.72
520107	BAR REINFORCING STEEL (CULVERT)	(F)	LB	600,000	\$3.00	\$1,800,000.00
	TYPE 85SW	(F)	LF	930	\$500.00	\$465,000.00
999990	MOBILIZATION (10%)		LS	1	\$1,506,900.00	\$1,506,900.00

SUBTOTAL (BRIDGE)	\$15,069,000
25% Contingency	\$3,767,250
<b>TOTAL COST</b>	<b>\$18,836,000</b>
\$ PER FT <sup>2</sup> (BRIDGE)*	\$407.43

\*Not including Bridge Removal

**Escalated Budget Estimate to Midpoint of Construction \***

Escalation Rate per Year

8.0%

\* Escalated budget estimate is provided for information only, actual construction costs may vary. Escalated budget estimates provided do not replace Departmental policy to update cost estimates annually.

Years Beyond Midpoint	Escalated Budget Est.
1	\$20,343,000
2	\$21,970,000
3	\$23,728,000

Years Beyond Midpoint	Escalated Budget Est.
4	\$25,626,000
5	\$27,676,000

**PSR#TD004 Baker Boulevard Bridge Over  
Mojave River Bridge Replacement**

FINAL INITIAL STUDY /  
MITIGATED NEGATIVE DECLARATION  
STATE CLEARINGHOUSE# 2025030204

---



**April 2025**

**PSR#TD004 Baker Boulevard Over Mojave River  
Bridge Replacement Project**

**State Clearinghouse# 2025030204**

**Prepared for:**



San Bernardino County  
Public Works Department  
825 East Third Street,  
San Bernardino, California 92415-0835

**Prepared by:**



Dokken Engineering  
110 Blue Ravine Road, Suite 200  
Folsom, California 95630

## TABLE OF CONTENTS

TABLE OF CONTENTS.....	i
LIST OF ABBREVIATIONS .....	iii
<b>1.0 INTRODUCTION .....</b>	<b>1</b>
1.1 Purpose and Background of the Initial Study.....	2
1.2 Lead Agency.....	3
1.3 Technical Studies .....	3
<b>2.0 PROJECT DESCRIPTION.....</b>	<b>4</b>
2.1 Project Location .....	5
2.2 Project Purpose and Objectives .....	5
2.3 Project Description.....	5
2.4 Required Project Approvals .....	9
<b>3.0 INITIAL STUDY CHECKLIST.....</b>	<b>10</b>
A. BACKGROUND .....	11
B. ENVIRONMENTAL FACTORS POTENTIALLY AFFECTED.....	14
C. DETERMINATION .....	15
D. EVALUATION OF ENVIRONMENTAL IMPACTS .....	16
I. Aesthetics .....	17
II. Agriculture and Forest Resources .....	26
III. Air Quality .....	29
IV. Biological Resources .....	41
V. Cultural Resources .....	65
VI. Energy .....	74
VII. Geology and Soils.....	76
VIII. Greenhouse Gas Emissions .....	83
IX. Hazards and Hazardous Materials .....	88
X. Hydrology and Water Quality .....	99
XI. Land use and Planning .....	111
XII. Mineral Resources .....	113
XIII. Noise .....	115
XIV. Population and Housing.....	122
XV. Public Services .....	123
XVI. Recreation .....	126
XVII. Transportation.....	128
XVIII. Tribal Cultural Resources.....	134
XIX. Utilities and Service Systems.....	139
XX. Wildfire.....	142

XXI. Mandatory Findings of Significance .....	144
<b>4.0 SUMMARY OF MITIGATION MEASURES .....</b>	<b>147</b>
<b>5.0 LIST OF PREPARERS .....</b>	<b>159</b>
<b>6.0 REFERENCES.....</b>	<b>161</b>

**List of Figures**

Figure 1. Project Vicinity .....	6
Figure 2. Project Location .....	7
Figure 3. Project Features.....	8
Figure 4. Area of Visual Effect.....	20
Figure 5. Habitat Communities.....	49
Figure 6. Biological Habitat Impacts .....	54
Figure 7. Area of Potential Effects.....	67
Figure 8. California Greenhouse Gas Inventory .....	85

**List of Tables**

Table 1. Required Project Approvals.....	9
Table 2. State and Federal Ambient Air Quality Standards .....	31
Table 3. State and Federal Attainment Status (MDAB) .....	36
Table 4. Summary of Comparative Emissions Analysis during Peak Hour .....	37
Table 5. Construction Emissions for Roadways .....	38
Table 6. Construction Fuel and Energy Consumption .....	75
Table 7. CO <sub>2</sub> Emissions during Peak Hour.....	87
Table 8. REC or AUL Evidence.....	94
Table 9. Noise Standards for Adjacent Mobile Noise Sources.....	117
Table 10. Construction Equipment Noise .....	120

**Appendices**

- Appendix A. Visual Impact Assessment
- Appendix B. Air Quality Report
- Appendix C. Natural Environment Study
- Appendix D. Hazardous Waste Initial Site Assessment Report
- Appendix E. Water Quality Assessment
- Appendix F. Noise Study
- Appendix G. Traffic Memorandum
- Appendix H: CEQA Cultural Resources Technical Report (Redacted)
- Appendix I: Public Comments and Responses

## LIST OF ABBREVIATIONS

AB	Assembly Bill
ACLUP	Airport Comprehensive Land Use Plan
ADL	Aerially Deposited Lead
ADT	Average Daily Traffic
APE	Area of Potential Effects
ACMs	Asbestos Containing Materials
AQMP	Air Quality Management Plan
ARB	Air Resources Board
AULs	Activity and Use Limitations
AVE	Area of Visual Effect
BMPs	Best Management Practices
BRIS	Bridge Inspection Reports
BSA	Biological Study Area
CAA	Clean Air Act
CAAQS	California Ambient Air Quality Standards
CAG	Community Action Guides
CalEPA	California Environmental Protection Agency
Caltrans	California Department of Transportation
CAP	Climate Action Plan
CAPCOA	California Air Pollution Control Officers Association
CARB	California Air Resources Board
CCA	Federal Clean Air Act
CCAA	California Clean Air Act
CCR	California Code of Regulations
CDF	Coastal Doug Fir
CDFW	California Department of Fish and Wildlife
CESA	California Endangered Species Act
CEQA	California Environmental Quality Act
CFD	Community facilities district
CFG	California Fish and Game
CFR	Code of Federal Regulation
CGP	Construction General Permit
CHRIS	California Historical Resources Information System
CH <sub>4</sub>	Methane
Corps	U.S. Army Corps of Engineers

CNDDDB	California Natural Diversity Database
CNEL	Community Noise Equivalent Level
CNPS	California Native Plant Society
CO	Carbon Monoxide
CO <sub>2</sub>	Carbon Dioxide
COI	Change of Information
CSA	County service areas
CSD	County Special District
CUPA	Certified Unified Program Agency
CWA	Clean Water Act
dBA	Decibel A-weighted
DOC	California Department of Conservation
DPM	Diesel Particulate Matter
DSA	Disturbed Soil Area
DT	Desert Turtle
DTSC	California Department of Toxic Substances Control
ECSZ	Eastern California Shear Zone
EDR	Environmental Data Resources
EIR	Environmental Impact Report
EO	Executive Order
EPA	Environmental Protection Agency
ESA	Environmentally Sensitive Area
FCD	Flood Control District
FEMA	Federal Emergency Management Agency
FESA	Federal Endangered Species Act
FIRM	Flood Insurance Rate Map
FMMP	Farmland Mapping and Monitoring Program
FHWA	Federal Highways Administration
FRA	Federal Responsibility Area
FTIP	Federal Transportation Improvement Program
GLO	General Land Office
GHG	Greenhouse gases
HFCs	Hydrofluorocarbons
HOT	High-occupancy toll
HOV	High-occupancy vehicle
HSC	California Health and Safety Code Section
IPCC	Intergovernmental Panel on Climate Change

IS	Initial Study
ISA	Initial Site Assessment
Ldn	Day-Night Level
LED	Light Emitting Diode
Leq	Equivalent Continuous Sound Level
Lmax	Maximum Sound Level
LRA	Local Responsibility Area
Lxx	Percentile-Exceeded Sound Level
MBTA	Migratory Bird Treaty Act
MLD	Most Likely Descendent
MLHP	Measure 1 Major Local Highway Projects
MND	Mitigated Negative Declaration
MPO	Metropolitan Planning Organization
MS4	Municipal Separate Storm Sewer Systems
msl	Mean sea level
MWD	Metropolitan Water District
MDAQMD	Mojave Desert Air Quality Management District
NAAQS	National Ambient Air Quality Standards
NAHC	Native American Heritage Commission
NALs	Numeric Action Levels
NELs	Numeric Effluent Limits
NEPA	National Environmental Protection Act
NHTSA	National Highway Traffic Safety Administration
NMFS	National Marine Fisheries Service
NOI	Notice of Intent
NOT	Notice of Termination
NPDES	National Pollutant Discharge Elimination System
N <sub>2</sub> O	Nitrous oxide
NO <sub>2</sub>	Nitrogen Dioxide
NO <sub>x</sub>	Nitrogen Oxides
NOA	Naturally Occurring Asbestos
NOAA	National Oceanic and Atmospheric Administration
NPDES	National Pollutant Discharge Elimination System
NRCS	Natural Resource Conservation Service
NSR	New Source Review
O <sub>3</sub>	Ozone
OHP	Office of Historic Preservation

ONRW	Outstanding National Resource Water
OPR	Office of Planning and Research
PCB	Polychlorinated Biphenyl
PCEs	Passenger Car Equivalencies
PFCs	Perfluorocarbons
PM	Particulate Matter
ppm	Parts per Million
PRC	Public Resources Code
PRDs	Project Registration Documents
Project	PSR#TD004 Baker Boulevard Bridge Over Mojave River Channel Bridge Replacement Project
QPEs	Qualifying Precipitation Events
QSD	Qualified Stormwater Pollution Prevention Plan Developer
QSP	Qualified Stormwater Pollution Prevention Plan Practitioner
R	Rainfall Erosivity
RE	Renewable energy
RECs	Recognized Environmental Conditions
ROG	Reactive organic compounds
RSP	Rock Slope Protection
RTP	Regional Transportation Plan
RUSLE	Revised Universal Soil Loss Equation
RWQCB	Regional Water Quality Control Board
SBCFPD	San Bernardino County Fire Protection District
SBCTA	San Bernardino County Transportation Authority
SBTAM+	San Bernardino Traffic Analysis Model Plus
SBCFPD	San Bernardino County Fire Protection District
SCCIC	South Central Coastal Information Center
SCS	Connect SoCal
SF6	Sulfur hexafluoride
SHPO	State Historic Preservation Office
SIP	State Implementation Plan
SLF	Sacred Lands File
SMARTS	Stormwater Multiple Application and Report Tracking System
SMARA	Surface Mining and Reclamation Act
SO <sub>2</sub>	Sulfur Dioxide
SPCCP	Spill Prevention, Control, and Countermeasure Program
SR	State Route
SRA	State Responsibility Area

SSC	Species of Special Concern
STIP	State Transportation Improvement Plan
STP	Surface Transportation Plan
SWP	State Water Project
SWPPP	Storm Water Pollution Prevention Plan
SWRCB	State Water Resources Control Board
TAC	Toxic Air Contaminant
TAG	Traffic Analysis Guidelines
TCM	Transportation control measure
TCE	Temporary construction easement
TCRs	Tribal Cultural Resources
TMDLs	Total Maximum Daily Loads
UMCP	University of California Museum of Paleontology
USACE	United States Army Corps of Engineers
USDOT	United States Department of Transportation
USFWS	United States Fish and Wildlife Service
USEPA	United States Environmental Protection Agency
USGS	United States Geological Survey
VMT	Vehicle miles traveled
VOC	Volatile organic compounds
WDID	Waste discharge Identification
WRA	Wastewater Reclamation Authority

---

# **1.0 INTRODUCTION**

---

### 1.1 Purpose and Background of the Initial Study

This document is an Initial Study (IS) with supporting environmental studies, which provides justification for a Mitigated Negative Declaration (MND) pursuant to the California Environmental Quality Act (CEQA) for the PSR#TD004 Baker Boulevard Over Mojave River Bridge Replacement Project (Project).

The purpose of this IS/MND is to evaluate the potential environmental impacts of the proposed Project. Mitigation measures have also been established that reduce or eliminate any identified significant and/or potentially significant impacts.

The IS/MND is a public document to be used by the San Bernardino County (County), acting as the CEQA lead agency, to determine whether the proposed Project may have a significant effect on the environment, pursuant to CEQA. If the lead agency finds substantial evidence that any aspect of the proposed Project, either individually or cumulatively, may have a significant effect on the environment that cannot be mitigated to a less than significant level, regardless of whether the overall effect of the proposed Project is adverse or beneficial, the lead agency is required to prepare an Environmental Impact Report (EIR), use a previously prepared EIR and supplement that EIR, or prepare a subsequent EIR to analyze the Project at hand (Public Resources Code Sections 21080(d), 21082.2(d)).

If the agency finds no substantial evidence that the proposed Project or any of its aspects may cause a significant impact on the environment with mitigation, a MND shall be prepared with a written statement describing the reasons why the proposed Project, which is not exempt from CEQA, would not have a significant effect on the environment, and therefore, why it does not require the preparation of an EIR (State CEQA Guidelines Section 15371).

According to State CEQA Guidelines Section 15070, a Negative Declaration shall be prepared for a project subject to CEQA when either:

- 1) *The initial study shows there is no substantial evidence, in light of the whole record before the agency, that the project may have a significant effect on the environment, or*
- 2) *The initial study identifies potentially significant effects, but:*
  - a) *Revisions in the project plans or proposals made by, or agreed to by the applicant before the proposed MND and initial study are released for public review would avoid the effects or mitigate the effects to a point where clearly no significant effects would occur, and*
  - b) *There is no substantial evidence, in light of the whole record before the agency, that the proposed project as revised may have a significant effect on the environment.*

This IS/MND has been prepared in accordance with CEQA, Public Resources Code Section 21000 et seq., and the State CEQA Guidelines Title 14 California Code of Regulations (CCR) Section 15000 et seq.

The Draft Initial Study circulated to the public from March 11, 2025 to April 11, 2025. Comments received during this period are included in Appendix I. Changes to the document made since the draft document circulation are shown as underlined text for text additions and strike-through text

## 1.0 INTRODUCTION

---

for text deletions. All modified text is also indicated by a black line in the left margin of each page. Minor editorial changes and clarifications are not shown.

### 1.2 Lead Agency

The lead agency is the public agency with primary responsibility over a proposed project. Where two or more public agencies will be involved with a project, CEQA Guidelines Section 15051 provides criteria for identifying the lead agency. In accordance with CEQA Guidelines Section 15051(b)(1), "The lead agency will normally be the agency with general governmental powers." The County has initiated preliminary design of the proposed Project and it requires approval from the San Bernardino County Board of Supervisors. Therefore, based on the criteria described above, the lead agency for the proposed Project is the County.

### 1.3 Technical Studies

Technical studies prepared for the proposed Project and referenced in this IS/MND are listed below. The technical studies are available at the San Bernardino Public Works Department, Environmental Management Division, upon request. Please reach out to Arnold (AJ) Gerber at [arnold.gerber@dpw.sbcounty.gov](mailto:arnold.gerber@dpw.sbcounty.gov) or (909) 387-8109 to request a copy.

- CEQA Cultural Resources Technical Report, Baker Boulevard Bridge (No. 54C0127) over Mojave River Replacement Project San Bernardino County, California, Dokken Engineering (confidential information has been redacted)
- Hazardous Waste Initial Site Assessment, PSR#TD004 Baker Boulevard Over Mojave River Bridge Replacement Project, Dokken Engineering
- Historic Property Survey Report/Archaeological Survey Report, PSR#TD004 Baker Boulevard Over Mojave River Replacement Project, Dokken Engineering - Please note that due to the inclusion of sensitive and confidential information, the cultural report is not available to the general public
- Hydrology, Hydraulics, and Scour Analysis, Baker Boulevard Bridge (No. 54C0127) over Mojave River Replacement Project San Bernardino County, California, River Focus, Inc.
- Natural Environment Study, PSR#TD004 Baker Boulevard Over Mojave River Bridge Replacement Project, Dokken Engineering
- Noise Study Report, PSR#TD004 Baker Boulevard Over Mojave River Bridge Replacement Project, Dokken Engineering
- Paleontological Letter Report, PSR#TD004 Baker Boulevard Over Mojave River Bridge Replacement Project, Cogstone
- Traffic Memorandum, Baker Bridge Replacement and Travel Demand Forecasting Memo, Fehr and Peers
- Visual Impact Assessment Memorandum, Baker Boulevard over Mojave River Bridge Replacement Project, Dokken Engineering
- Water Quality Assessment Report, PSR#TD004 Baker Boulevard Over Mojave River Bridge Replacement Project, Dokken Engineering

---

## 2.0 PROJECT DESCRIPTION

---

### 2.1 Project Location

The San Bernardino County, Department of Public Works (County) in cooperation with the California Department of Transportation (Caltrans), proposes to replace the existing two lane timber bridge on Baker Boulevard, with a new four lane structure located near the unincorporated community of Baker in San Bernardino County, California (**Figure 1. Project Vicinity** and **Figure 2. Project Location**).

### 2.2 Project Purpose and Objectives

The purpose of the proposed Project is to improve structure safety and operations through replacement of the existing bridge and approach roadways. The proposed Project is needed to meet current bridge structural design and safety standards along with projected future traffic capacity needs albeit the project in and of itself will not generate increase traffic volume and/or demand.

### 2.3 Project Description

#### Background

The existing bridge was originally built in 1931 as a 93-foot (plus or minus) 5 span simple-supported stringer timber bridge crossing the Mojave River Channel on Baker Boulevard (formerly US 91 and State Route 31). It was repaired and lengthened in 1938. Repairs conducted in 1938 included replacement of all untreated Douglas Fir timber within the existing bridge with Redwood; the addition of 9 new spans to the west and 8 new spans to the east increasing bridge overall length to 408-feet (plus or minus), and channel excavation for the length of the structure to maintain a minimum clearance of 6-feet below the bottom stringer (soffit) of the bridge. The bridge currently exists as a 22-span simple-supported stringer timber bridge with a 5- to 6-inch-thick continuous cast in place reinforced concrete deck overlain with asphalt concrete and closed end reinforced concrete struttled abutments supported on Coastal Douglas Fir (CDF) timber piles. The bents and abutments are set at a 45-degree skew to accommodate flows within the Mojave River Channel below. Timber railing and plywood planking accommodating an elevated 2-foot-wide walk on both sides of the bridge is worn and deteriorating. Current sufficiency rating per Caltrans biannual bridge inspection reports (BRIS) for the structure is roughly 76.

#### Build Alternative

The Project includes the demolition of the existing two-lane 22 span simple-supported stringer timber bridge and its replacement with a four-lane, 10-span cast-in-place reinforced concrete slab structure founded on cast-in-drilled hole piles (CIDH) or driven concrete pile extensions (**Figure 3. Project Features**). This proposed structure will meet and address County and American Association of State Highway and Transportation Officials (AASHTO) standards and criteria, or equivalent. Approximately 1,200 feet of approach roadway work would be required to widen Baker Boulevard to its ultimate width. The design would construct and/or tie into existing, planned and projected ultimate roadway improvements from 0.14 miles west of the existing structure to Death Valley Road (State Highway 127). Additionally, the new bridge will include sidewalks, streetlights, and bridge barrier railing meeting current MASH safety and testing requirements. Existing driveways located within the Project area may require improvements to ensure conformity with the widened bridge and roadway approaches. Further, the existing mid-block pedestrian crossing located approximately 300 feet southwest of the Mojave River Channel may also be removed, including striping and signage.

It is anticipated that excavators, dozers, dump trucks, concrete trucks, drill rigs, pile driving rigs and concrete pumps will be required to rehabilitate and widen the existing road surface and replace the bridge. Temporary and permanent right of way acquisition may be required for construction.

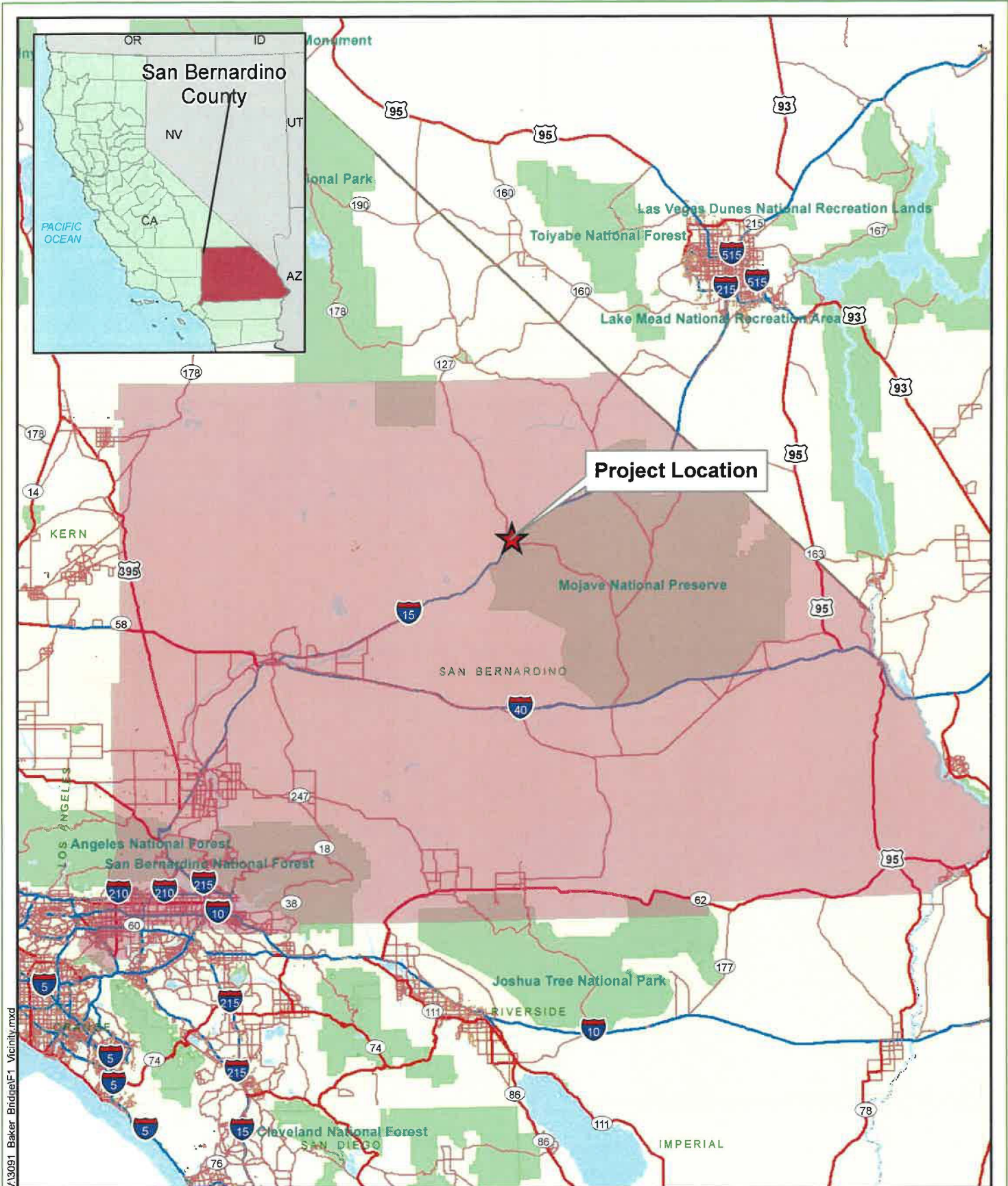

V:\3091\_Baker\_Bridge\F1\_Vicinity.mxd

Source: ESRI 2008; Dokken Engineering 10/24/2024; Created By: amyd

**FIGURE 1**  
**Project Vicinity**

PSR#TD004 Baker Boulevard Over Mojave River Bridge Replacement  
STPL-5954(193)  
Baker, San Bernardino County, California

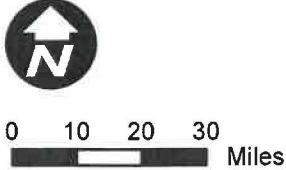



v:\1836 11thStBridge\Cultural\F2 Loc 10-12-10.mxd

Source: ESRI World Street Maps Online; Dokken Engineering 10/24/2024; Created By: amyd



**FIGURE 2**  
**Project Location**

PSR#TD004 Baker Boulevard Over Mojave River Bridge Replacement  
STPL-5954(193)  
Baker, San Bernardino County, California



## 2.0 PROJECT DESCRIPTION

The existing structure is well suited for either staged construction, with part of the new structure built adjacent to the existing bridge prior to removal of the existing bridge or a full detour (1.25-mile detour length) using adjacent SR-127/I-15 and the local road network to provide a complete closure for construction. Both options will keep the new bridge and approach road widenings within existing ROW. The Project will require relocation of overhead utilities, utilities attached to the bridge, and may require relocation of underground utilities along the roadway approaches. Construction may start as early as 2026 and may last 24 months.

The proposed Project may construct a permanent ramp providing access into the San Bernardino County (SBC) Flood Control District (FCD) owned floodway channel north of the bridge along the eastern levee to better facilitate channel maintenance and future bridge inspections.

### No Build Alternative

Under the no-build alternative, the existing bridge would not be repaired. The worn and deteriorating 86 plus year old timber bridge would not be improved.

### Funding and Responsible Entities

The proposed Project will be utilizing local funds and federal funds from the Federal Highways Administration (FHWA), administered through Caltrans. As such, the proposed Project requires compliance with both the National Environmental Policy Act (NEPA) and the California Environmental Quality Act (CEQA). The lead agency for NEPA compliance is Caltrans and the lead agency for CEQA compliance is the County.

The proposed Project is included in the 2023 Federal Transportation Improvement Program (FTIP) and the Regional Transportation Plan/ 2024 Connect SoCal (RTP/SCS). The Project will be primarily using local funds from Measure I Major Local Highway Projects (MLHP). Funding for construction, which needs to be obligated by FY 25/26, will utilize Measure I MLHP along with state and federal funds under the State Transportation Improvement Program (STIP – local) and the Surface Transportation Program (STP), administered by San Bernardino County Transportation Authority (SBCTA).

## 2.4 Required Project Approvals

To implement the Project, a series of actions and approvals would be required from regulatory and other government agencies. Anticipated Project approvals would include, but are not limited to the following:

**Table 1. Required Project Approvals**

Agency	Permit/Approval	Status
San Bernardino County Board of Supervisors	Adoption of MND and MMRP	Anticipated 2025
Caltrans	Encroachment Permit	Will be obtained after approval of the final environmental document and prior to construction.
Lahontan Regional Water Quality Control Board	Waste Discharge Requirements	Will be obtained after approval of the final environmental document and prior to construction.
SWRCB	Construction General Permit and National Pollutant Discharge Elimination System	Will be Obtained Prior to Construction
California Department of Fish and Wildlife (CDFW)	Section 1602 Streambed Alteration Agreement	Will be obtained after approval of the final environmental document and prior to construction.
San Bernardino County Flood Control District	Encroachment Permit	Will be Obtained Prior to Construction

---

# 3.0 INITIAL STUDY CHECKLIST

---

**A. BACKGROUND**

**1. Project Title:**

PSR#TD004 Baker Boulevard Bridge Over Mojave River Bridge Replacement Project

**2. Lead Agency Name and Address:**

San Bernardino County  
Public Works Department  
825 East Third Street,  
San Bernardino, California 92415-0835

**3. Contact Person Phone Number:**

Arnold (AJ) Gerber  
Senior Planner  
Department of Public Works  
Environmental Management Division  
825 E. Third Street, Rm. 123  
San Bernardino, CA 92415-0835  
(909) 387-8109  
arnold.gerber@dpw.sbcounty.gov

**4. Project Location:**

The proposed PSR#TD004 Baker Boulevard Over Mojave River Bridge Replacement Project (Project) is located in the community of Baker, California. The Project area consists of an approximately 15.95 acres and includes segments of Baker Boulevard, the existing two-lane 22 span simple-supported stringer timber bridge, the Mojave River Channel, and approximately 1,200 feet of approach roadway required to widen Baker Boulevard to its ultimate width. The design would construct and/or tie into existing, planned and projected ultimate roadway improvements from 0.14 miles west of the existing structure to Death Valley Road (State Highway 127). (Figures 1-3).

**5. Project Applicant's Name and Address:**

San Bernardino County  
Public Works Department  
825 East Third Street,  
San Bernardino, California 92415-0835

**6. General Plan Designation:**

Commercial (C), Public Facility (PF) and Limited Industrial (LI)

**7. Zoning:**

Highway Commercial (CH), Floodway (FW), and Rural Commercial (CR)

#### 8. Description of Project:

The Project includes the demolition of the existing two-lane 22 span simple-supported stringer timber bridge and its replacement with a four-lane, 10-span cast-in-place reinforced concrete slab structure founded on cast-in-drilled hole piles (CIDH) or driven concrete pile extensions (**Figure 3. Project Features**). This proposed structure will meet and address County and American Association of State Highway and Transportation Officials (AASHTO) standards and criteria, or equivalent. Approximately 1,200 feet of approach roadway work would be required to widen Baker Boulevard to its ultimate width. The design would construct and/or tie into existing, planned and projected ultimate roadway improvements from 0.14 miles west of the existing structure to Death Valley Road (State Highway 127). Additionally, the new bridge will include sidewalks, streetlights, and bridge barrier railing meeting current MASH safety and testing requirements. Existing driveways located within the Project area may require improvements to ensure conformity with the widened bridge and roadway approaches. Further, the existing mid-block pedestrian crossing located approximately 300 feet southwest of the Mojave River Channel may also be removed, including striping and signage.

It is anticipated that excavators, dozers, dump trucks, concrete trucks, drill rigs, pile driving rigs and concrete pumps will be required to rehabilitate and widen the existing road surface and replace the bridge. Temporary and permanent right of way acquisition may be required for construction. The existing structure is well suited for either staged construction, with part of the new structure built adjacent to the existing bridge prior to removal of the existing bridge or a full detour (1.25-mile detour length) using adjacent SR-127/I-15 and the local road network to provide a complete closure for construction. Both options will keep the new bridge and approach road widenings within existing ROW. The Project will require relocation of overhead utilities, utilities attached to the bridge, and may require relocation of underground utilities along the roadway approaches. Construction may start as early as 2026 and may last 24 months.

The proposed Project may construct a permanent ramp providing access into the San Bernardino County (SBC) Flood Control District (FCD) owned floodway channel north of the bridge along the eastern levee to better facilitate channel maintenance and future bridge inspections.

The proposed Project will be utilizing local funds and federal funds from the Federal Highways Administration (FHWA), administered through Caltrans. As such, the proposed Project requires compliance with both the National Environmental Policy Act (NEPA) and the California Environmental Quality Act (CEQA). The lead agency for NEPA compliance is Caltrans and the lead agency for CEQA compliance is the County.

The proposed Project is included in the 2023 Federal Transportation Improvement Program (FTIP) and the Regional Transportation Plan/ 2024 Connect SoCal (RTP/SCS). The Project will be primarily using local funds from Measure I Major Local Highway Projects (MLHP). Funding for construction, which needs to be obligated by FY 25/26, will utilize Measure I MLHP along with state and federal funds under the State Transportation Improvement Program (STIP – local) and the Surface Transportation Program (STP), administered by San Bernardino County Transportation Authority (SBCTA).

#### 9. Surrounding Land Uses and Setting:

The current land uses within the Project area include Commercial (C), Public Facility (PF) and Limited Industrial (LI). The current zoning designations within the Project area include Highway Commercial (CH), Floodway (FW), and Rural Commercial (CR).

The Project area is relatively flat with no major topographic features. The land use in the surrounding area is primarily commercial development. The parcels south of the existing bridge within the Project area are zoned as CH. This land use zoning district provides sites for retail trade and personal services, lodging services, office and professional services, recreation and entertainment services, wholesaling and warehousing, contract/construction services, transportation services, open lot services, and similar and compatible uses. The parcels north of the existing bridge within the Project area are zoned as CR. This land use zoning district provides sites for retail trade and personal services, repair services, lodging services, recreation and entertainment services, transportation services, and similar and compatible uses. Agriculture and residential uses are also allowed but are secondary in importance. A portion of the Mojave River Channel is also present within the Project area and is zoned as FW. The FW land use zoning district provides sites for animal keeping, grazing, crop production, and similar and compatible uses.

**B. ENVIRONMENTAL FACTORS POTENTIALLY AFFECTED**

The environmental factors checked below could result in potentially significant impacts if mitigation measures are not implemented. As discussed on the following pages, where potentially significant impacts are identified, feasible mitigation was identified to reduce the impacts to a less than significant level. Therefore, potentially significant impacts that are mitigated to “Less Than Significant” are shown here.

- |   |  |  |
|---|--|--|
| <input checked="" type="checkbox"/> Aesthetics              | <input type="checkbox"/> Agriculture and Forestry      | <input type="checkbox"/> Air Quality                                   |
| <input checked="" type="checkbox"/> Biological Resources    | <input checked="" type="checkbox"/> Cultural Resources | <input type="checkbox"/> Energy  |
| <input checked="" type="checkbox"/> Geology/Soils           | <input type="checkbox"/> Greenhouse Gas Emissions      | <input checked="" type="checkbox"/> Hazards and Hazardous Materials    |
| <input checked="" type="checkbox"/> Hydrology/Water Quality | <input type="checkbox"/> Land Use/Planning             | <input type="checkbox"/> Mineral Resources                             |
| <input checked="" type="checkbox"/> Noise                   | <input type="checkbox"/> Population/Housing            | <input type="checkbox"/> Public Services                               |
| <input type="checkbox"/> Recreation                         | <input type="checkbox"/> Transportation                | <input checked="" type="checkbox"/> Tribal Cultural Resources          |
| <input type="checkbox"/> Utilities/Service Systems          | <input type="checkbox"/> Wildfire                      | <input checked="" type="checkbox"/> Mandatory Findings of Significance |

C. DETERMINATION

On the basis of this initial evaluation:

- I find that the proposed project COULD NOT have a significant effect on the environment, and a NEGATIVE DECLARATION will be prepared.
- I find that although the proposed project could have a significant effect on the environment, there will not be a significant effect in this case because revisions in the project have been made by or agreed to by the project proponent. A MITIGATED NEGATIVE DECLARATION will be prepared.
- I find that the proposed project MAY have a significant effect on the environment, and an ENVIRONMENTAL IMPACT REPORT is required.
- I find that the proposed project MAY have a "potentially significant impact" or "potentially significant unless mitigated" impact on the environment, but at least one effect 1) has been adequately analyzed in an earlier document pursuant to applicable legal standards, and 2) has been addressed by mitigation measures based on the earlier analysis as described on attached sheets. An ENVIRONMENTAL IMPACT REPORT is required, but it must analyze only the effects that remain to be addressed.
- I find that although the proposed project could have a significant effect on the environment, because all potentially significant effects (a) have been analyzed adequately in an earlier EIR or NEGATIVE DECLARATION pursuant to applicable standards, and (b) have been avoided or mitigated pursuant to that earlier EIR or NEGATIVE DECLARATION, including revisions or mitigation measures that are imposed upon the proposed project, nothing further is required.

*Nancy Sansonetti*

04.17.25

Nancy J. Sansonetti, AICP  
Supervising Planner  
Department of Public Works  
Environmental Management  
Division San Bernardino County

Date

**REPORT/RECOMMENDATION TO THE BOARD OF SUPERVISORS  
OF SAN BERNARDINO COUNTY  
AND RECORD OF ACTION**

April 29, 2025

**FROM**

**NOEL CASTILLO, Director, Department of Public Works - Transportation**

**SUBJECT**

Initial Study/Mitigated Negative Declaration for the Baker Boulevard Bridge Over Mojave River Bridge Replacement Project

**RECOMMENDATION(S)**

1. Certify that the Initial Study/Mitigated Negative Declaration (State Clearinghouse No. 2025030204) for the Baker Boulevard Bridge Over Mojave River Bridge Replacement Project, in the Baker area, has been completed in compliance with the California Environmental Quality Act, has been reviewed and considered prior to approving the project, and that the report reflects the independent judgement of the Board of Supervisors.
2. Adopt the Mitigated Negative Declaration for the Baker Boulevard Bridge Over Mojave River Bridge Replacement Project, in the Baker area.
3. Adopt the Mitigation Monitoring and Reporting Program for the Baker Boulevard Bridge Over Mojave River Bridge Replacement Project, in the Baker area, as provided in Section 4 of the Initial Study/Mitigated Negative Declaration.
4. Direct the Department of Public Works to file the Notice of Determination in accordance with the California Environmental Quality Act.

(Presenter: Noel Castillo, Director, 387-7906)

**COUNTY AND CHIEF EXECUTIVE OFFICER GOALS & OBJECTIVES**

**Ensure Development of a Well-Planned, Balanced, and Sustainable County.  
Provide for the Safety, Health and Social Service Needs of County Residents.**

**FINANCIAL IMPACT**

Approval of this item will not result in the use of Discretionary General Funding (Net County Cost). The Baker Boulevard Bridge Over Mojave River Bridge Replacement Project (Project), is funded by Measure I North Desert Subarea Major Local Highways Program (MLHP), administered by the San Bernadino County Transportation Authority (SBCTA) for design and environmental. Funding for construction will utilize Measure I MLHP along with state and federal funds under the Surface Transportation Program (STP - local), allocated to SBCTA. The requested administrative actions have minimal financial impacts on the Department of Public Works (Department). Sufficient revenue and appropriation are included in the Department's 2024-25 Road Operations budget (6650002000 H14278) and will be included in future recommended budgets as necessary.

**BACKGROUND INFORMATION**

The San Bernardino County Department of Public Works (County) in cooperation with the California Department of Transportation (Caltrans), proposes to replace the existing two-lane

**Initial Study/Mitigated Negative Declaration for the Baker Boulevard  
Bridge Over Mojave River Bridge Replacement Project  
April 29, 2025**

timber bridge on Baker Boulevard crossing over the Mojave River, with a new four lane structure located near the unincorporated community of Baker in San Bernardino County, California. The purpose of the proposed Project is to improve structure safety and operations through the replacement of the existing bridge and approach roadways. The proposed Project is needed to meet current bridge structural design and safety standards while accommodating future traffic capacity needs. However, the Project itself will not generate an increase in traffic volume or demand.

The existing bridge, originally constructed in 1931, was a simple-supported stringer timber bridge spanning approximately 93-feet over the Mojave River on Baker Boulevard (formerly State Route 31). In 1938, the bridge underwent significant repairs and expansion, including the replacement of all untreated Douglas Fir timber with Redwood. The bridge was lengthened with the addition of nine new spans to the west and eight to the east, extending its total length to approximately 408 feet. Channel excavation was also performed to maintain a minimum clearance of six feet below the bottom stringer.

The proposed project involves demolishing the existing two-lane, 22-span, simple-supported stringer timber bridge and replacing it with a new four-lane structure. The Project is funded by both state and federal sources, requiring compliance with both the National Environmental Policy Act (NEPA) and the California Environmental Quality Act (CEQA), with Caltrans serving as the lead agency for NEPA compliance and the County as the lead agency for CEQA compliance.

Under CEQA, environmental review must be completed before project initiation. As the lead agency, the County Board of Supervisors is the appropriate authority to adopt the state environmental document. On September 27, 2022 (Item No. 79), the San Bernardino County Board of Supervisors (Board) approved on-call Contract No. 22-912 with Dokken Engineering (Dokken) for engineering and other services. This contract was utilized for preparation of an environmental Initial Study/Mitigated Negative Declaration (IS/MND) for the Project.

Dokken prepared a draft IS/MND and a Notice of Intent/Notice of Availability for the proposed IS/MND, which was circulated for a period of 30 days beginning on March 11, 2025, through the Office of Planning and Research, State Clearinghouse. A Notice of Intent was also distributed to responsible and trustee agencies, interested parties, and surrounding property owners, with the completed draft of the IS/MND for the same 30-day period beginning on March 11, 2025. Mitigation measures determined to be needed to reduce potential impacts to the lowest level possible were included in a Mitigation Monitoring and Reporting Program included as Section 4 of the IS/MND entitled "Summary of Mitigation Measures."

The Project will meet the County's and Chief Executive Officer's goals and objectives of ensuring the development of a well-planned, balanced, and sustainable County and providing for the safety, health and social service needs of County residents by replacing structurally deficient bridges.

**PROCUREMENT**

Not applicable.

**REVIEW BY OTHERS**

This item has been reviewed by County Counsel (Aaron Gest, Deputy County Counsel, 387-

**Initial Study/Mitigated Negative Declaration for the Baker Boulevard  
Bridge Over Mojave River Bridge Replacement Project  
April 29, 2025**

5455) on April 3, 2025; Finance (Kathleen Gonzalez, Administrative Analyst, 387-4222 on April 10, 2025) and County Finance and Administration (Paloma Hernandez-Barker, Deputy Executive Officer, 387-5423) on April 14, 2025.

**Initial Study/Mitigated Negative Declaration for the Baker Boulevard  
Bridge Over Mojave River Bridge Replacement Project  
April 29, 2025**

Record of Action of the Board of Supervisors  
San Bernardino County

**APPROVED (CONSENT CALENDAR)**

Moved: Joe Baca, Jr. Seconded: Curt Hagman  
Ayes: Col. Paul Cook (Ret.), Jesse Armendarez, Dawn Rowe, Curt Hagman, Joe Baca, Jr.

Lynna Monell, CLERK OF THE BOARD

BY  \_\_\_\_\_  
DATED: April 29, 2025



cc: File - Transportation w/CD  
CCM 05/6/2025